

Standard (Metric Size) - AS*2F AS3002F-10

Datasheet

General series information

- Applicable Tubing O.D.: Ø 2 to Ø 12 mm
- Operating Pressure Range: 0.1 to 1 MPa.



Flow control valve, adjustable, with reverse free flow

Standard specifications

Body Size	300 (3/8 Standard)
Applicable Tube O.D.	10 (ø10)
Fixed Orifice	None
Option	None
Lock Nut	Standard (Hexagon)
Pressure medium	Compressed air
Maximum temperature of pressure medium	60 °C
Minimum temperature of pressure medium	-5 °C [without condensation]
Maximum operating pressure	1.0 MPa
Minimum operating pressure	0.1 MPa
Proof pressure	1.5 MPa
Maximum ambient temperature	60 °C
Minimum ambient temperature	-5 °C
Number of pneumatic connections	2 pcs.
Pneumatic input connection	Ø 10 mm
Pneumatic output connection	Ø 10 mm
Function of Flow control valve	Throttle valve
Usable tubing material	Soft Nylon;Nylon;Polyurethane
Weight	0.042 Kg

Dimensions

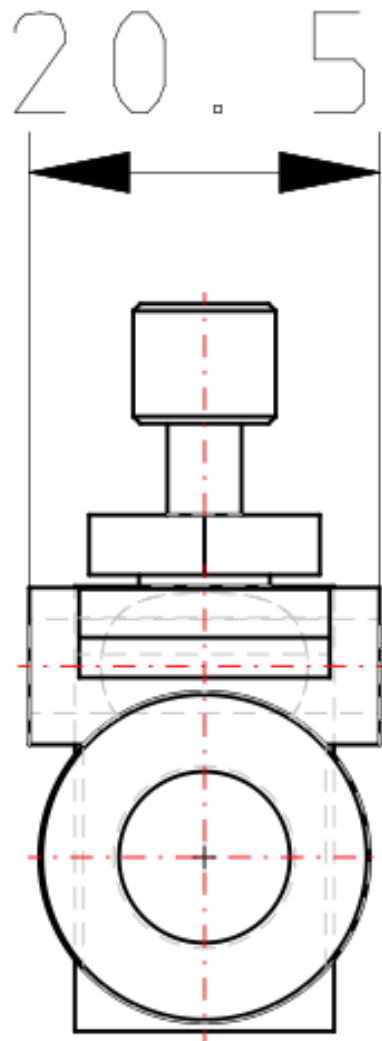

Constructions

AS1002F, AS2002F, AS2052F

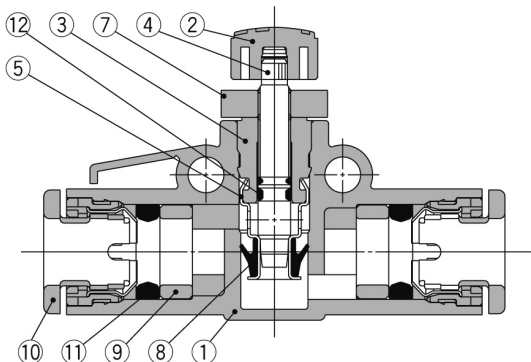

Component Parts

No.	Description	Material	Note
1	Body A	PBT	
2	Handle	PBT	
3	Body B	Brass	Electroless nickel plated
4	Needle	Brass	Electroless nickel plated
5	Seat ring	Brass	Electroless nickel plated
6	Needle guide	Brass	Electroless nickel plated

AS1002F-02, AS3002F, AS4002F

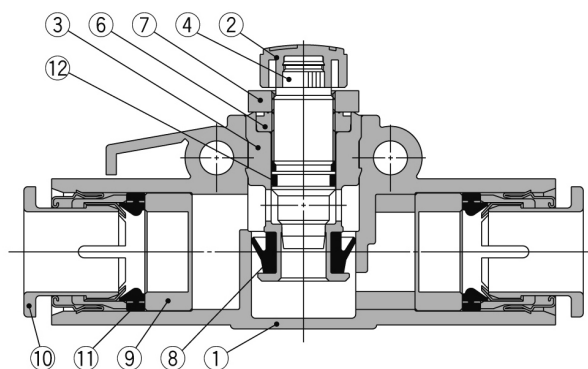

No.	Description	Material	Note
7	Lock nut	Steel wire	Zinc chromated
8	U-seal	HNBR	
9	Spacer	POM ^{Note)}	
10	Cassette	—	
11	Seal	NBR	
12	O-ring	NBR	

Note) AS2052F, AS3002F, AS4002F are made of PBT. AS3002F-11, AS4002F-11, AS4002F-13 are made of electroless nickel plated brass.

Additional information

Catalogue

[AS1002F-4002F-A_EU.pdf](#)