

CXSL, Dual Piston Rods, Ball Bushing Bearing CXSL20-30

Datasheet

General series information

- Dual rod cylinder with ball bearing slide
- Bore sizes: 6, 10, 15, 20, 25, 32 (mm)
- Strokes from 10mm through 100mm depending upon bore size
- Variety of switches and a variety of lead wire lengths

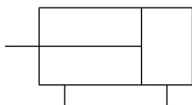

Double-acting, single-rod cylinder

Standard specifications

Thread port	M5 (Rc (PT) for sizes 25 to 32)
Bore Size	20mm
Thread	ø6-ø20 Bore: M Thread; ø25,32ø Bore: Rc 1/8
Lube-retainer	Without Stable Lubrication Function
Stroke	30mm
Auto Switch	No Switch
Lead Wire or Prewired Connector	0.5m [Or None in the Case of No Switch]
Number	2 pcs. [Or None in the Case of No Switch]
Pressure medium	Air (non-lube)
Maximum operating pressure	0.7 MPa
Minimum operating pressure	0.05 MPa
Proof pressure	1.05 MPa
Maximum ambient temperature	60 °C
Minimum ambient temperature	-10 °C
Number of pneumatic connections	2 pcs.
Mode of operation of drive	Double acting
Type of cushioning	Rubber Bumper
Port size	M5
Piston speed	30 - 700 mm/s

Stroke adjustable range	0 to – 5 mm compared to the standard stroke
Weight	0.500 Kg

Dimensions

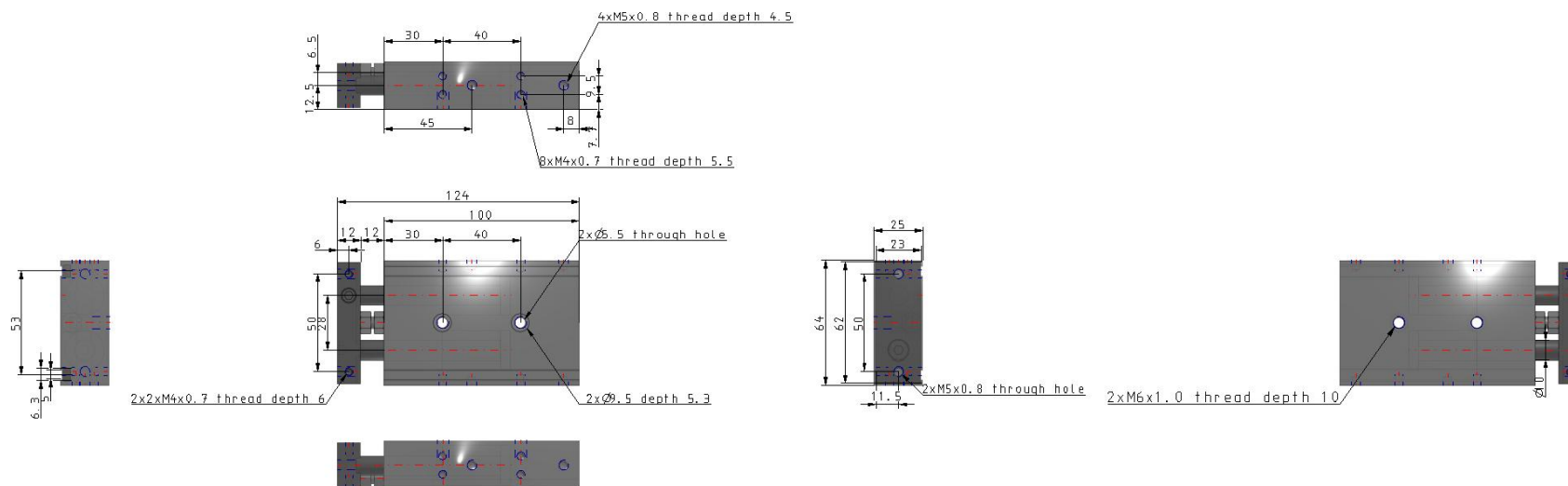

Constructions

CXSL20 to 32

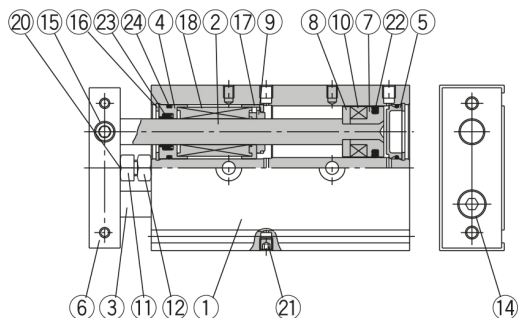

Parts list: Standard piping

No.	Description	Material	Note
1	Housing	Aluminum alloy	Hard anodized
2	Piston rod A	Special steel	Hard chrome plated
3	Piston rod B	Special steel	Hard chrome plated
4	Rod cover/Bearing	Aluminum alloy	
5	Head cover	Special steel ^{Note 1)}	
6	Plate	Aluminum alloy	Hard anodized
7	Piston A	Aluminum alloy	Chromated
8	Piston B	Aluminum alloy	Chromated
9	Bumper A	Polyurethane	
10	Magnet	Magnetic material	
11	Bumper bolt	Carbon steel	Nickel plated
12	Hexagon nut	Carbon steel	Nickel plated
13	Bumper B	Polyurethane	
14	Hexagon socket head cap screw	Chromium steel	Nickel plated
15	Hexagon socket head set screw	Chromium steel	Nickel plated
16	Snap ring	Special steel	Nickel plated
17	Bumper holder	Synthetic resin	



Note 1) Anodized aluminum alloy for CXSL6.

Parts list

No.	Description	Material	Note
18	Ball bushing	—	
19	Bearing spacer	Synthetic resin ^{Note 2)}	
20	Bumper	Polyurethane	
21	Plug	Chromium steel	Nickel plated
22	Piston seal	NBR	
23	Rod seal	NBR	
24	O-ring	NBR	
25	Head cover B	Aluminum alloy	Nickel plated
26	Seal retainer	Aluminum alloy	
27	Port spacer	Aluminum alloy	
28	Steel ball	Special steel	Hard chrome plated
29	Snap ring B	Special steel	Nickel plated

Note 2) Aluminum alloy for CXSL6.

Additional information

Catalogue

[CXS_EU.pdf](#)