

## CXSJ, Dual Rod Cylinder, Compact Type

### CXSJM6-40

Datasheet

### General series information

- Dual rod cylinder, compact type
- Slide bearing or ball bushing bearing
- Bore size (mm): 6, 10, 15, 20, 25, 32
- Standard strokes (mm): 10, 20, 30, 40, 50, 75, 100
- Auto switches available
- Made to Order additionally released.



Double-acting, single-rod cylinder

### Standard specifications

Bearing Style	M (Slide Bearing)
Bore Size	6 mm
Thread Type	Rc (or M Thread for 6 to 25 Bore)
Piping	Standard Porting
Stroke	40 mm
Auto Switch	No Switch
Lead Wire or Prewired Connector	0.5m [Or None in the Case of No Switch]
Number	2 pcs. [Or None in the Case of No Switch]
Option	None
Pressure medium	Air (non-lube)
Maximum operating pressure	0.7 MPa
Minimum operating pressure	0.15 MPa
Proof pressure	1.05 MPa
Maximum ambient temperature	60 °C
Minimum ambient temperature	-10 °C
Number of pneumatic connections	2 pcs.
Mode of operation of drive	Double acting

Type of cushioning	Rubber Bumper
Type of stroke reduction	Unilaterally retracted
Port size	M3
Piston speed	30 to 800 mm/s
Stroke adjustable range	0 to – 5 mm compared to the standard stroke
Weight	0.090 Kg

Specifications are subject to change without prior notice and any obligation on the part of the manufacturer.

# Dimensions

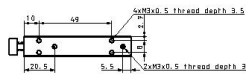
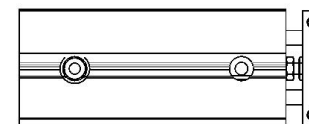
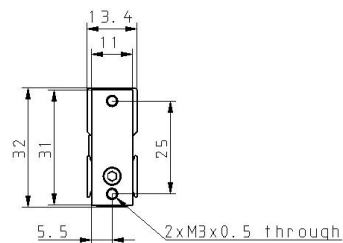
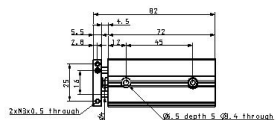
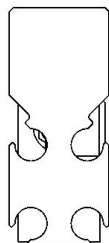

## Constructions

### CXSJM (Slide bearing)

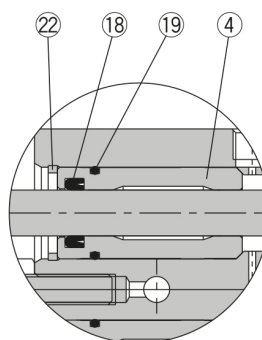
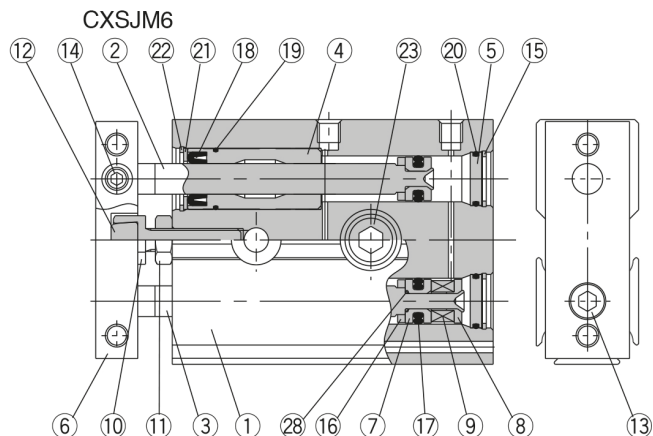

Rod cover

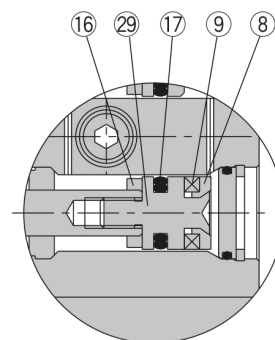

Piston rod B-side piston

### Parts list

No.	Description	Material	Note
1	<b>Housing</b>	Aluminum alloy	Hard anodized
2	<b>Piston rod A</b>	Carbon steel <small>Note)</small>	Hard chrome plated
3	<b>Piston rod B</b>	Carbon steel <small>Note)</small>	Hard chrome plated
4	<b>Rod cover/Bearing</b>	Aluminum alloy	
5	<b>Head cover</b>	Aluminum alloy	Anodized
6	<b>Plate</b>	Aluminum alloy	Glossy, self-coloring hard anodized
7	<b>Piston A</b>	Aluminum alloy	Chromated
8	<b>Piston B</b>	Aluminum alloy	Chromated
9	<b>Magnet</b>	Magnetic material	
10	<b>Bumper bolt</b>	Carbon steel	Nickel plated
11	<b>Hexagon nut</b>	Carbon steel	Nickel plated
12	<b>Bumper</b>	Polyurethane	
13	<b>Hexagon socket head cap screw</b>	Chromium steel	Nickel plated
14	<b>Hexagon socket head set screw</b>	Chromium steel	Nickel plated
15	<b>Snap ring</b>	Special steel	Nickel plated

Note) Stainless steel for CXSJM6.

No.	Description	Material	Note
16	<b>Bumper B</b>	Polyurethane	
17	<b>Piston seal</b>	NBR	
18	<b>Rod seal</b>	NBR	
19	<b>O-ring</b>	NBR	
20	<b>O-ring</b>	NBR	
21	<b>Seal retainer</b>	Stainless steel	
22	<b>Snap ring B</b>	Special steel	Nickel plated
23	<b>Bolt holder</b>	Stainless steel	
24	<b>Bearing spacer</b>	Aluminum alloy	
25	<b>Ball bushing</b>	—	
26	<b>Piston rod A</b>	Special steel	Hard chrome plated
27	<b>Piston rod B</b>	Special steel	Hard chrome plated
28	<b>O-ring</b>	NBR	
29	<b>Piston C</b>	Stainless steel	

## Additional information

Catalogue

[CXSJ\\_EU.pdf](#)

Operation manuals

[cxsj\\_op\\_man\\_cxsj-om0002h.pdf](#)