

CJP, Pin Cylinder, Single Acting, Spring Return CJPB15-10H4

Datasheet

General series information

- Single acting, spring return, pin cylinder
- Compact design-minimizes mounting space
- Three bore sizes available
- Strokes from 5mm to 15mm available
- Two mounting styles available



Single-acting cylinder, single piston rod, return stroke by spring

Standard specifications

Mounting	B (Panel Mount Style)
Bore Size	15mm
Stroke	10mm
Hose Nipple	H4 (For Tube Ø4/Ø2.5)
Rod End Thread	Thread
Maximum operating pressure	0.7 Mpa
Minimum operating pressure	0.15 MPa
Proof pressure	1.05 MPa
Type of cushioning	None
Lubrication	Not required (non-lube)
Ambient and fluid temperature	-10 - 70°C
Stroke length tolerance	+1.0 0
Thread Tolerance	JIS class 2
Piston speed	50 - 500 mm/s
Action	Single acting, spring return
Accessory (Standard equipment)	Mounting nut (2) Rod end nut (2)

Weight

0.082 Kg

Dimensions

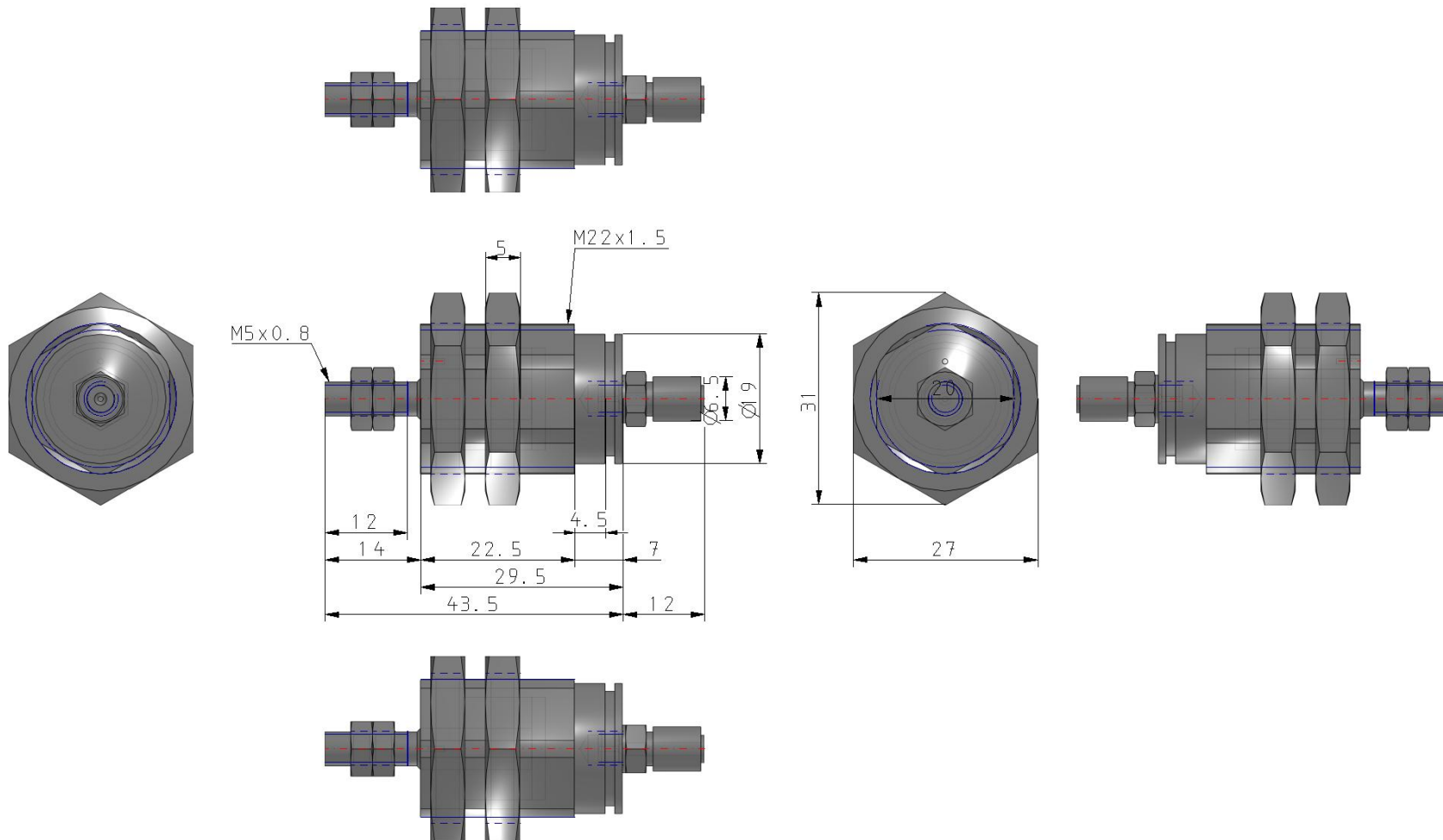

Constructions

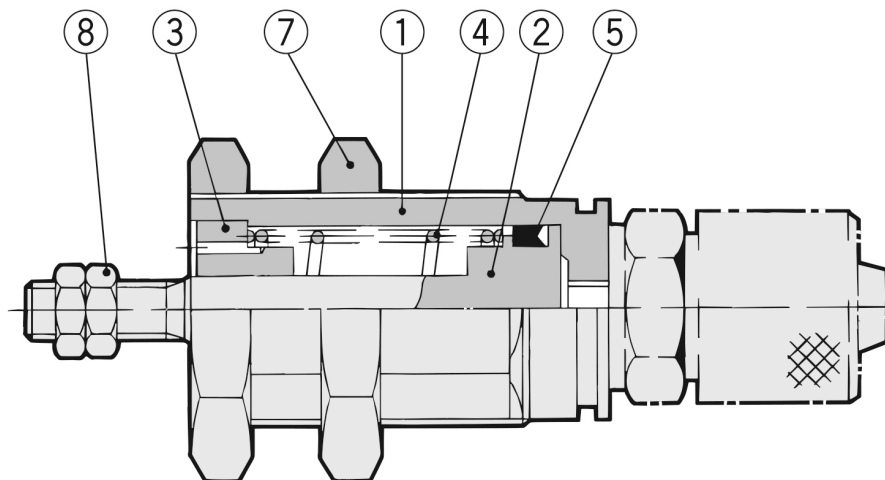

Component Parts

No.	Description	Material	Note	
1	Cover	Brass	Electroless nickel plated	
2	Piston	Stainless steel		
3	Collar	Oil-impregnated sintered alloy	ø4	Brass + Electroless nickel plated
			ø6, ø10	Bronze
4	Return spring	Steel wire	Zinc chromated	
5	Piston seal	NBR		
7	Mounting nut	Brass	Electroless nickel plated	
8	Rod end nut	Steel	Nickel plated	

Additional information

Catalogue	CJP2-CJP_EU.pdf
Operation manuals	cjp_cjp_-om0002c-a.pdf