

In-line - AS*2FS AS2002FS-06

Datasheet

General series information

- Applicable Tubing O.D.: Ø 3.2 to Ø 12 mm and Ø 1/8" to Ø 1/2"
- Operating Pressure Range: 0.1 to 1 MPa.

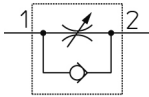

Flow control valve, adjustable, with reverse free flow

Standard specifications

Body Size	200 (1/8 Standard)
Indicator Direction	0°
Applicable Tube O.D.	06 (ø6)
Pressure medium	Air
Maximum operating pressure	1 MPa
Minimum operating pressure	0.1 MPa
Proof pressure	1.5 MPa
Maximum ambient temperature	60 °C
Minimum ambient temperature	-5 °C
Applicable tubing material	Nylon, Soft nylon, Polyurethane
Weight	0.010 Kg

Dimensions

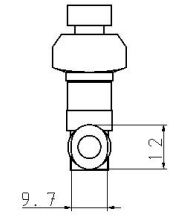
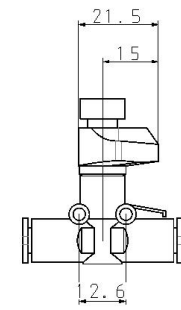
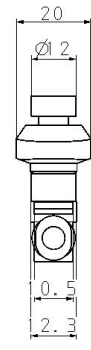
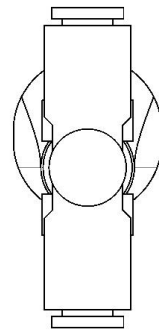
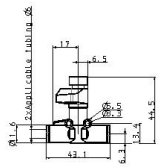

Constructions

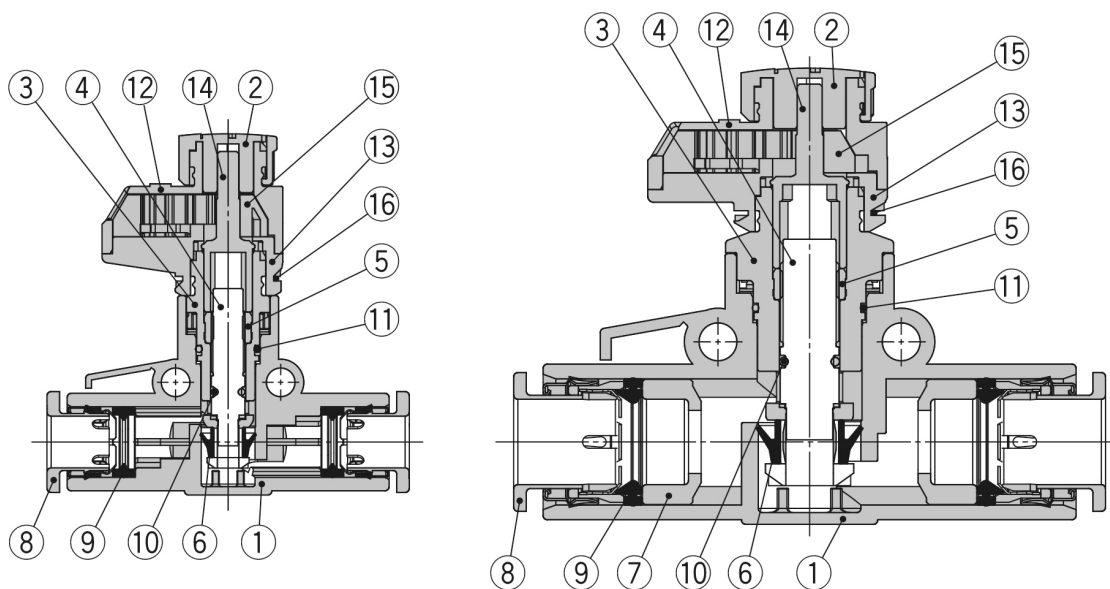

Component Parts

No.	Description	Material	Note
1	Body A	PBT	
2	Knob	POM	
3	Body B	PBT	
4	Needle	PBT	
5	Needle guide	Brass	Electroless nickel plating
6	U-seal	HNBR	
7	Spacer	PBT*1	
8	Cassette	—	
9	Seal	NBR	
10	O-ring	NBR	
11	O-ring	NBR	
12	Bonnet A	POM	
13	Bonnet B	POM	
14	Gear	PPS	
15	Indicator gear	POM	
16	Clip	Stainless steel	

*1 The AS3002FS□-11, AS4002FS□-11, AS4002FS□-13 are made of electroless nickel plated brass.

Additional information

Catalogue

[AS-FS-B_in-line_EU.pdf](#)