

MXQ*B-Z, Air Slide Table, Low Thrust with High Rigidity Type MXQ8B-10Z

Datasheet

General series information

- Higher rigidity: Guide rigidity improved by 50%.
- Up to 23% more compact.
- Up to 44% lighter.
- 55% Less air consumption.

Standard specifications

Bore Size	8 mm
Body Option	B (Standard)
Stroke	10 mm
Adjuster Option	Z (Without Adjuster)
Auto Switch	No Switch
Lead Wire or Prewired Connector	0.5m (Or None in the Case of No Switch)
Number	2 pcs. (Or None in the Case of No Switch)
Made to Order	None
Pressure medium	Compressed air
Maximum temperature of pressure medium	60 °C
Minimum temperature of pressure medium	-10 °C
Maximum operating pressure	0.7 MPa
Minimum operating pressure	0.15 MPa
Proof pressure	1.05 MPa
Maximum ambient temperature	60 °C
Minimum ambient temperature	-10 °C
Number of pneumatic connections	2 pcs.
Pneumatic input connection	M5 x 0.8
Mode of operation of drive	Double acting

Theoretical cylinder force, advance stroke (at 0.5 MPa)	51 N
Theoretical cylinder force, return stroke (at 0.5 MPa)	38 N
Maximum piston speed	500 mm/s
Type of cushioning	Internal rubber bumper
Weight	0.220 Kg

Dimensions

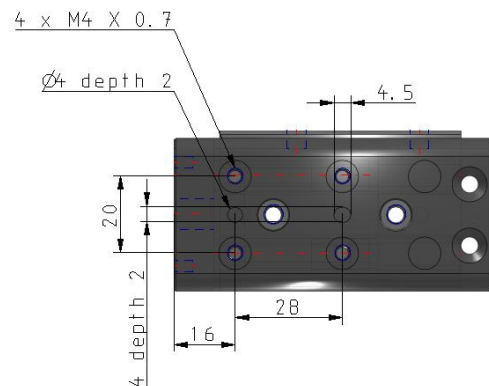
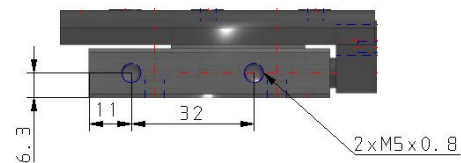
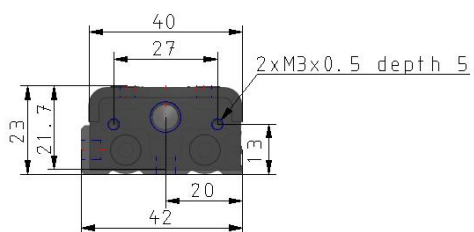
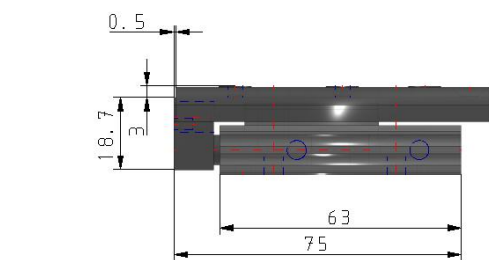
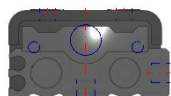
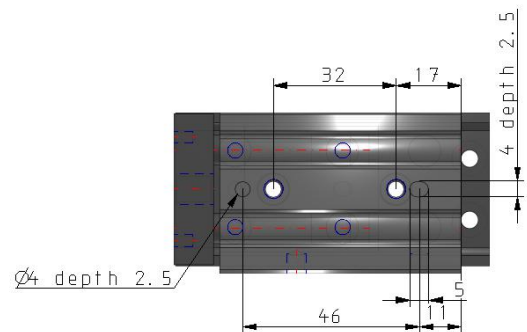

Additional information

Catalogue

[MXQ-Z-C_EU.pdf](#)

Operation manuals

[OM_MXQ-Z_OMP0038EN-D.pdf](#)