

C(D)55, Compact Cylinder ISO Standard (ISO 21287) CD55B63-125M

Datasheet

General series information

- Conforms with the ISO 21287 standard.
- Bore sizes of 20, 25, 32, 40, 50, 63, 80 & 100 mm.
- Large stroke range from 5 mm up to 150 mm.
- Construction is similar to the current CQ2 lateral load resistant specification.
- Snap ring construction allows easy and quicker maintenance.
- Auto switches can be mounted on any of the four sides of the cylinder tube.

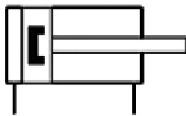

Double-acting, single-rod cylinder

Standard specifications

Built-in Magnet	D (With Magnet)
Mounting Style	B (Standard)
Bore Size	63mm
Stroke	125
Rod End Thread	M (Rod End Male Thread)
Auto Switch	No Switch
Lead Wire or Prewired Connector	0.5m [Or None in the Case of No Switch]
Number	2 pcs. [Or None in the Case of No Switch]
Rod End Options	None
Made of Stainless Steel	None
Pressure medium	Air
Maximum temperature of pressure medium	70 °C
Maximum temperature of pressure medium with magnet	60 °C
Minimum temperature of pressure medium	-10 °C (No freezing)
Minimum temperature of pressure medium with magnet	-10 °C (No freezing)
Maximum operating pressure	1.0 MPa
Minimum operating pressure	0.05 MPa

Proof pressure	1.5 MPa
Maximum ambient temperature	70 °C
Maximum ambient temperature with magnet	60 °C
Minimum ambient temperature	-10 °C (No freezing)
Minimum ambient temperature with magnet	-10 °C (No freezing)
Number of pneumatic connections	2 pcs.
Pneumatic input connection	G 1/8
Pneumatic exhaust connection	G 1/8
Mode of operation of drive	Double acting
Theoretical cylinder force, advance stroke (at 0.5 MPa)	1560 N
Theoretical cylinder force, return stroke (at 0.5 MPa)	1400 N
Maximum piston speed	500 mm/s
Type of cushioning	Rubber bumper on both end
Geometric form of the piston rod	Single rod
Male thread of rod end	M12 x 1.25
Female thread of rod end	M10 x 1.5
Weight	1.680 Kg

Dimensions

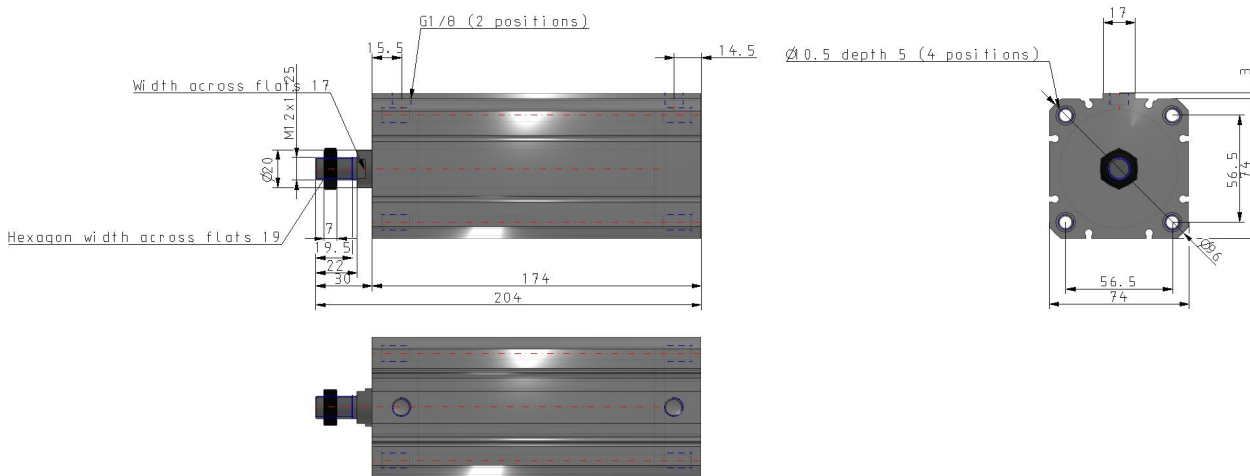

Constructions

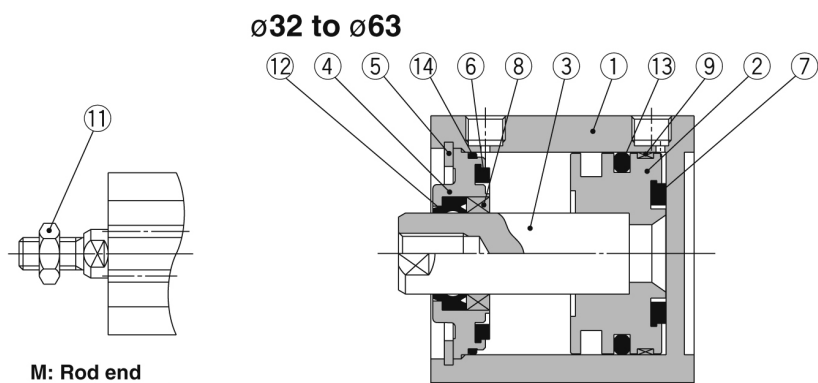

M: Rod end male thread

With auto switch (Built-in magnet)

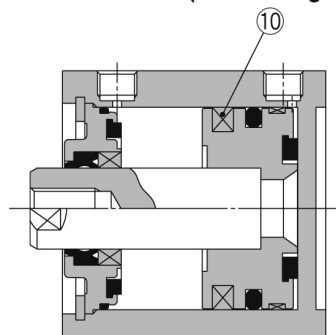

Component Parts

No.	Description	Material	Note
1	Cylinder tube	Aluminum alloy	Hard anodised
2	Piston	Aluminum alloy	Chromated
3	Piston rod	Stainless steel	ø20, ø25
		Carbon steel	ø32 to ø100 Hard chrome plated
4	Collar	Aluminum alloy	ø20 to ø40 Anodized
		Aluminum alloy casted	ø50 to ø100 Painted after chromated
5	Retaining ring	Carbon tool steel	Phosphate coated
6	Bumper A	Urethane	
7	Bumper B	Urethane	
8	Bushing	Bearing alloy	
9	Wear ring	Resin	ø20 to ø63
10	Magnet	—	
11	Rod end nut	Carbon steel	Nickel plated
12	Rod seal	NBR	
13	Piston seal	NBR	
14	Tube gasket	NBR	

Replacement Parts/Seal Kit

Bore size (mm)	Kit no.	Contents
20	CQ2B20-PS	Set of nos. at left (12, 13, 14)
25	CQ2B25-PS	
32	CQ2B32-PS	
40	CQ2B40-PS	
50	CQ2B50-PS	
63	CQ2B63-PS	
100	CQ2B100-PS	

* Seal kit includes 12, 13, 14. Order the seal kit, based on each bore size.

Additional information

Catalogue	C55-B_EU.pdf
Operation manuals	c55_c55-om00031.pdf