

MK-Z Rotary Clamp Cylinder, Standard w/Auto Switch Mounting Grooves

MKB50-20LZ

Datasheet

General series information

- Length has been reduced in comparison to MK2 and is similar in length to MK.
- Bore sizes (mm): 12, 16, 20, 25, 32, 40, 50, 63
- Compact auto switch D-M9 can be mounted on 4 sides.
- Magnetic field resistant auto switch can be used.
- 2 types of cylinder mounting are available with one body.



Double-acting, single-rod cylinder

Standard specifications

Mounting	B (Through-hole/Both Ends Tapped Common, Basic)
Bore Size	Ø50 mm
Port Thread	M thread: ø12 to ø25, Rc: 32 to 63
Clamp Stroke	20 mm
Rotary Direction	L (Counterclockwise)
Body Option	Standard (Female Thread)
Auto Switch	No Switch
Lead Wire or Prewired Connector	0.5m [Or None in the Case of No Switch]
Number	2 pcs. [Or None in the Case of No Switch]
Made to Order	None
Pressure medium	Air
Maximum temperature of pressure medium	70 °C
Maximum temperature of pressure medium with magnet	60 °C
Minimum temperature of pressure medium	-10 °C (No freezing)
Minimum temperature of pressure medium with magnet	-10 °C (No freezing)
Maximum operating pressure	1.0 MPa
Minimum operating pressure	0.1 MPa
Proof pressure	1.5 MPa

Maximum ambient temperature	70 °C
Maximum ambient temperature with magnet	60 °C
Minimum ambient temperature	-10 °C (No freezing)
Minimum ambient temperature with magnet	-10 °C (No freezing)
Number of pneumatic connections	2 pcs.
Pneumatic input connection	R 1/4
Pneumatic exhaust connection	R 1/4
Mode of operation of drive	Double acting
Theoretical cylinder force, advance stroke (at 0.5 MPa)	982 N
Theoretical cylinder force, return stroke (at 0.5 MPa)	825 N
Maximum piston speed	200 mm/s
Type of cushioning	Rubber bumper
Piston rod end	Female thread
Female thread of rod end	M12
Weight	1.357 Kg

Dimensions

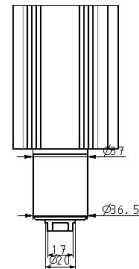
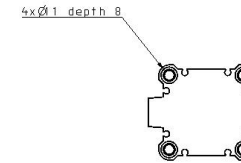
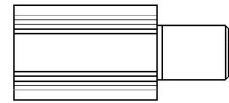
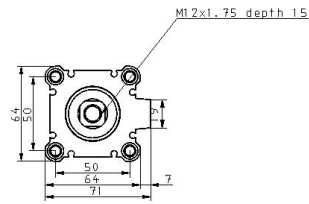
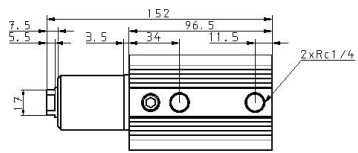
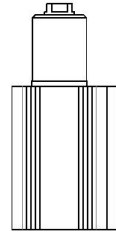

Constructions

With arm (N)

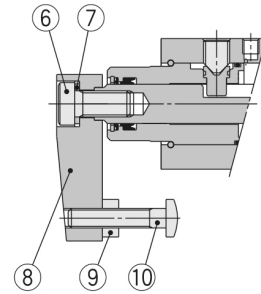

New MK40 to 63

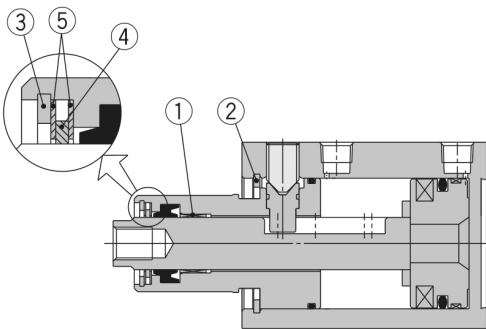

Head flange (G)

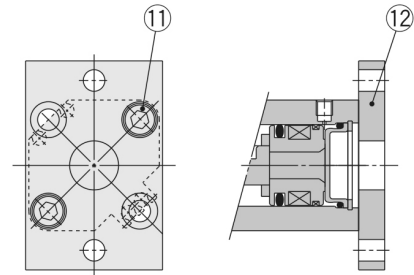

Component Parts

No.	Description	Material	Note
1	Bushing	Copper bearing material	
2	Round R-type retaining ring	Carbon tool steel	
3	Round R-type retaining ring	Carbon tool steel	
4	Coil scraper	Phosphor bronze	
5	Scraper pressure	Stainless steel	
6	Hexagon socket head cap screw	Chromium molybdenum steel	
7	Spring washer	Hard steel	
8	Arm	Rolled steel	
9	Hexagon nut	Rolled steel	
10	Clamp bolt	Chromium molybdenum steel	
11	Hexagon socket head cap screw	Chromium molybdenum steel	ø40: 4 pcs.
12	Flange	Rolled steel	

Additional information

Catalogue

[MK-A_EU.pdf](#)