

AR-B, Regulator & Regulator w/Backflow Function AR30-F02H-B

Datasheet

General series information

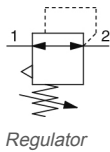

Standard specifications

Made to Order 1	None
Body Size	30
Backflow Function	None
Thread	F (G)
Port	02 (1/4)
Option	H (w/Set Nut, for Panel Mount)
Semi-Standard	Standard
Made to Order 2	None
Pressure medium	Air
Maximum operating pressure	1.0 MPa
Proof pressure	1.5 MPa
Maximum ambient temperature	60 °C
Minimum ambient temperature	-5 °C (with no freezing)
Approvals	No need
Weight	0.309 Kg

Dimensions

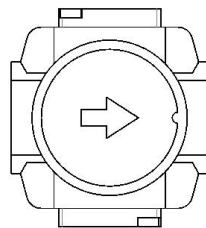
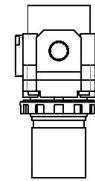
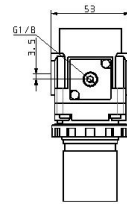
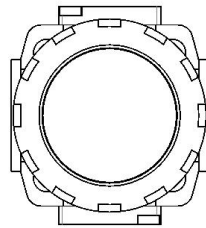
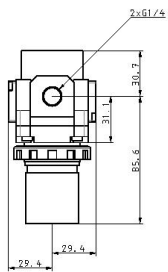

Constructions

AR30(K)-B/AR40(K)-B

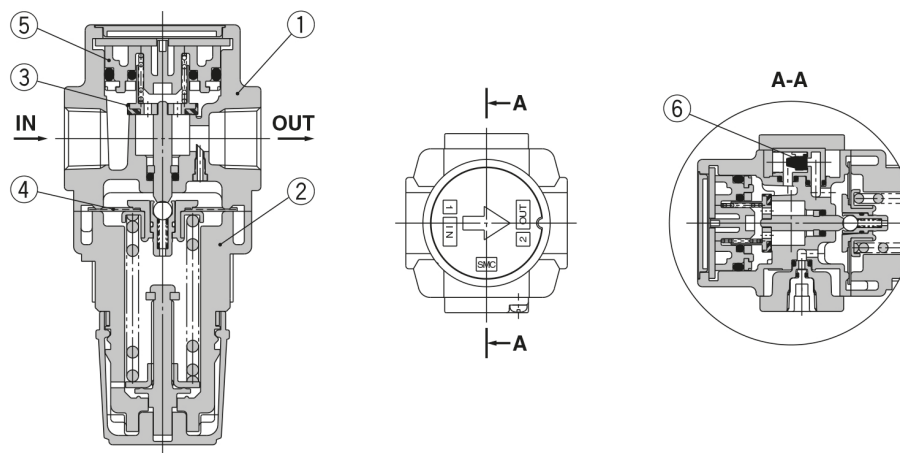

Component Parts

No.	Description	Material	Model	Colour
1	Body	Zinc die-cast	AR10-A	White
		Aluminium die-cast	AR20(K)-B to AR60(K)-B	
2	Bonnet	Polyacetal	AR10-A	White
			AR20(K)-B to AR40(K)-B	
		Aluminium die-cast	AR50(K)-B/AR60(K)-B	

[AR20(K)-B to AR60(K)-B]

No.	Description	Material	Part no.						
			AR20(K)-B	AR25(K)-B	AR30(K)-B	AR40(K)-B	AR40(K)-06-B	AR50(K)-B	AR60(K)-B
3	Valve	Brass, HNBR	AR20P-410S	AR25P-410S	AR30P-410S	AR40P-410S		AR50P-410S	AR60P-410S
4	Diaphragm assembly	Weatherable NBR	AR20P-150AS	AR25P-150AS	AR30P-150AS	AR40P-150AS		AR50P-150AS	
5	Valve guide assembly	Polyacetal	AR20P-050AS	AR25P-050AS	AR30P-050AS	AR40P-050AS		AR50P-050AS	AR60P-050AS
6	Check valve assembly ^{*1}	—	AR23KP-020AS						

*1 Check valve assembly is applicable for a regulator with backflow function (AR20K-B to AR60K-B) only.
 Assembly of a check valve cover, check valve body assembly and 2 mounting screws

Additional information

Catalogue	AC-B-B_EU.pdf
Installation manuals	IM_AR-B_TF2Z394EN.pdf
Operation manuals	OM_AR-B_OMS0056EN.pdf OM_ARxK-B_OMT0015EN.pdf