

## C(D)Q2, Compact Cylinder, Double Acting, Single Rod w/Auto Switch Mounting Groove

### CDQ2B32-30DZ

Datasheet

### General series information

- Double acting, single rod, compact cylinder
- Bore sizes (mm): 12, 16, 20, 25, 32, 40, 50, 63, 80, 100
- Standard stroke range (mm): 5 to 100
- Port threads: M (12 to 25 bore); Rc, NPT or G (32 to 100 bore)
- Can mount small auto switches on 4 surfaces.



### Standard specifications

Magnet	D (Built-in)
Mounting	B (Through Hole [Standard])
Type	Standard
Bore Size	Ø32 mm
Port Thread Type	Rc (or M Thread for 16 & 20 Bore or 32 stroke 5mm)
Lube-retainer	Without Stable Lubrication Function
Stroke	30
Body Option	Standard [Rod End Female Thread]
Auto Switch Groove	Z [Auto Switch Mounting Grooves]
Mounting Bolt	None
Rod End Bracket	None
Auto Switch	No Switch
Lead Wire or Prewired Connector	0.5 m or None in the Case of No Switch
Number	2 pcs.
Rod End Options	None
Temperature Resistance	None
Low Speed	None
Made of Stainless Steel	None

Fluororubber Seal	None
Pressure medium	Compressed air
Maximum temperature of pressure medium	60 °C
Minimum temperature of pressure medium	-10 °C
Maximum operating pressure	1.0 MPa
Minimum operating pressure	0,05 Mpa
Proof pressure	1.5 MPa
Maximum ambient temperature	60 °C
Minimum ambient temperature	-10 °C
Number of pneumatic connections	2 pcs.
Pneumatic input connection	Rc 1/8
Mode of operation of drive	Double acting
Theoretical cylinder force, advance stroke (at 0.5 MPa)	402 N
Theoretical cylinder force, return stroke (at 0.5 MPa)	302 N
Maximum piston speed	500 mm/s
Geometric form of the piston rod	Single rod
Male thread of rod end	M14 x 1.5
Female thread of rod end	M8 x 1.25
Minimum piston speed	50 mm/s
Weight	0.281 Kg

## Dimensions

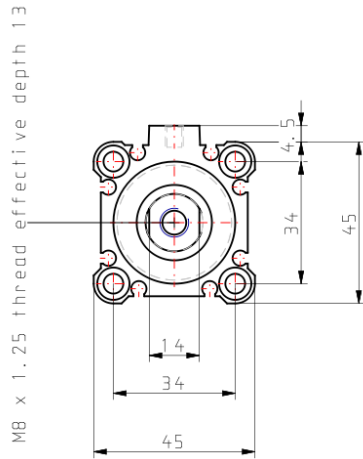

2x1 / 8 (Rc, NPT, G) (Port size)

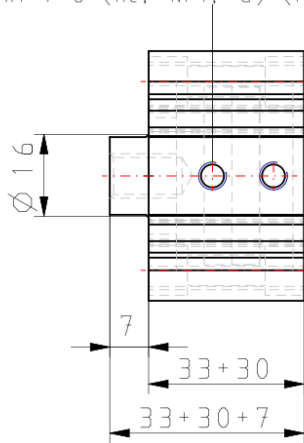

## Constructions



### Component Parts

No.	Description	Material	Note
1	<b>Cylinder tube</b>	Aluminum alloy	Hard anodised
2	<b>Piston</b>	Aluminum alloy	Chromated
3	<b>Piston rod</b>	Stainless steel	ø12 to ø25
		Carbon steel	ø32 to ø100, Hard chrome plated
4	<b>Collar</b>	Aluminum alloy	ø12 to ø40, Anodised
		Aluminum alloy casted	ø50 to ø100, Chromated, Painted
5	<b>Retaining ring</b>	Carbon tool steel	Phosphate coated
6	<b>Bushing</b>	Bearing alloy	For ø50 or more only
7	<b>Magnet</b>	—	
8	<b>Piston seal</b>	NBR	
9	<b>Rod seal</b>	NBR	
10	<b>Gasket</b>	NBR	

## Additional information

Catalogue

[CQ2-Z-C\\_EU.pdf](#)