

C(D)QS, Compact Cylinder, Double Acting, Single Rod CDQSB20-100DCM

Datasheet

- Standard double acting single rod
- Bore sizes: 12, 16, 20, 25 (mm)
- Strokes from 5mm through 300mm depending upon bore size
- Mounts: through hole/both ends tapped, foot, front or rear flanges, double clevis
- Variety of switches and a variety of lead wire lengths

Standard specifications

Magnet	D (Built-in)
Mounting	B (Through Hole, Both Ends Tapped)
Bore Size	Ø20 mm
Lube-retainer	Without Stable Lubrication Function
Stroke	100
Option	C (Rubber Bumper)
Auto Switch	No Switch
Lead Wire or Prewired Connector	M (1 m)
Number	2 pcs.
Dust Resistant	None
Rod End Options	None
Pressure medium	Air
Conform to the European RoHS Directive	Conform
Number of pneumatic connections	2 pcs.
Mode of operation of drive	Double acting
Geometric form of the piston rod	Round piston rod
Weight	0.410 Kg

Dimensions

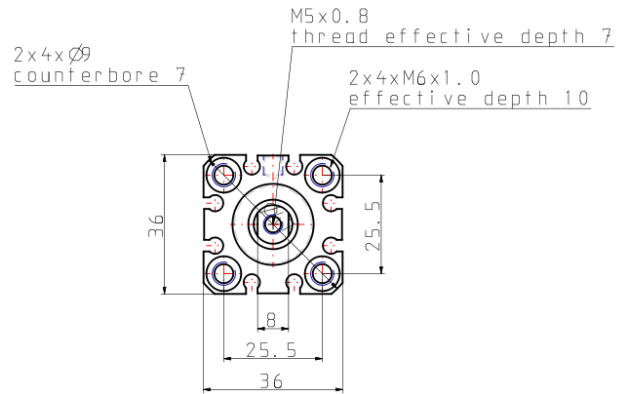
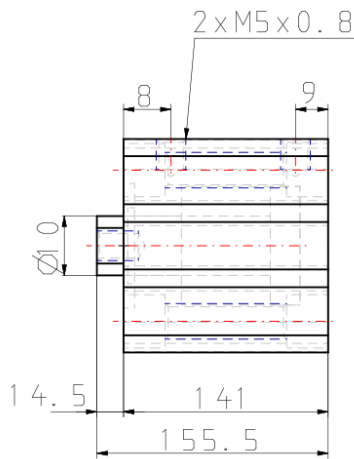
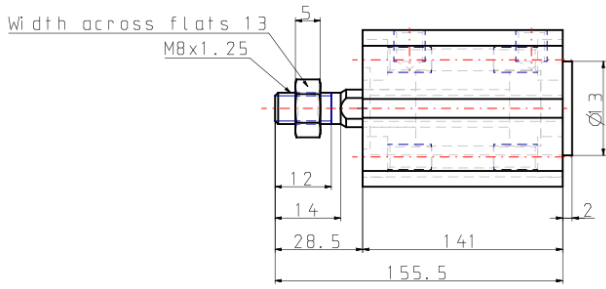

Additional information

Catalogue

[CQS_EU.pdf](#)