

C(D)QS, Compact Cylinder, Double Acting, Single Rod CDQSB25-40D

Datasheet

General series information

- Standard double acting single rod
- Bore sizes: 12, 16, 20, 25 (mm)
- Strokes from 5mm through 300mm depending upon bore size
- Mounts: through hole/both ends tapped, foot, front or rear flanges, double clevis
- Variety of switches and a variety of lead wire lengths



Double-acting, single-rod cylinder

Standard specifications

Magnet	D (Built-in)
Mounting	B (Through Hole, Both Ends Tapped)
Bore Size	Ø25 mm
Lube-retainer	Without Stable Lubrication Function
Stroke	40
Option	Standard (Rod End Female Thread)
Auto Switch	No Switch
Lead Wire or Prewired Connector	0.5 m (Or None in the Case of No Switch)
Number	2 pcs.
Rod End Options	None
Pressure medium	Air
Maximum temperature of pressure medium	60 °C
Minimum temperature of pressure medium	-10 °C
Maximum operating pressure	1.0 MPa
Minimum operating pressure	0.05 MPa
Proof pressure	1.5 MPa
Maximum ambient temperature	60 °C
Minimum ambient temperature	-10 °C

Number of pneumatic connections	2 pcs.
Pneumatic input connection	M5
Mode of operation of drive	Double acting
Theoretical cylinder force, advance stroke (at 0.5 MPa)	245 N
Theoretical cylinder force, return stroke (at 0.5 MPa)	189 N
Maximum piston speed	500 mm/s
Piston rod end	External thread
Geometric form of the piston rod	Round piston rod
Male thread of rod end	M10 x 1.25
Female thread of rod end	M6
Minimum piston speed	50 mm/s
Lubrication	Non-lube
Weight	0.240 Kg

Dimensions

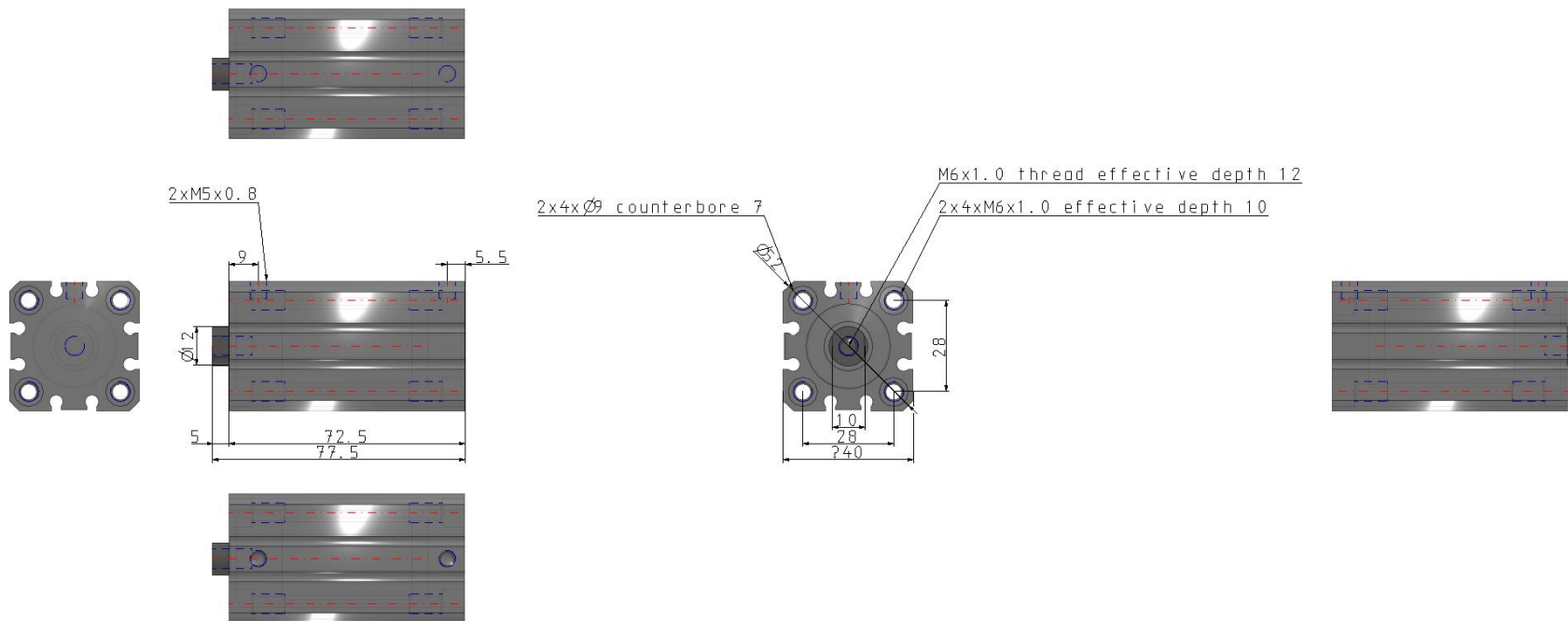

Constructions

Construction

**With auto switch
(Built-in magnet)
ø20, ø25**

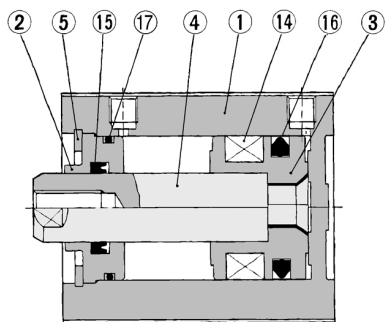

Component Parts

No.	Description	Material	Note
①	Cylinder tube	Aluminum alloy	Hard anodized
②	Collar	Aluminum bearing alloy	Anodized
③	Piston	Aluminum alloy	Chromated
④	Piston rod	Stainless steel	
⑤	Snap ring	Carbon tool steel	Phosphate coating
⑭	Magnet	—	
⑮	Rod seal	NBR	
⑯	Piston seal	NBR	
⑰	Tube gasket	NBR	

Additional information

Catalogue

[CQS_EU.pdf](#)