

KK*S-*M, S-Couplers, Male Thread KK3S-02MS

Datasheet

General series information

- Male thread.
- Body size: M5, 1/8, 1/4, 1/2.
- Applicable Port Size: M5, R1/8, R1/4, R3/8, R1/2, R3/4.

Standard specifications

Body Size	3 (1/8)
Piping Port Size	R 1/4
Sealant	S (With Sealant)
Pressure medium	Air, Water
Maximum operating pressure	1.0 MPa
Minimum operating pressure	-90 kPa
Proof pressure	1.5 MPa
Maximum ambient temperature	60 °C / 40 °C for Water
Minimum ambient temperature	-5 °C (with no freezing) / 5 °C for Water
Effective Area	20 mm ²
Sealing principle	Electroless nickel plated (copper-free application), With male thread sealant
Weight	0.019 Kg

Dimensions

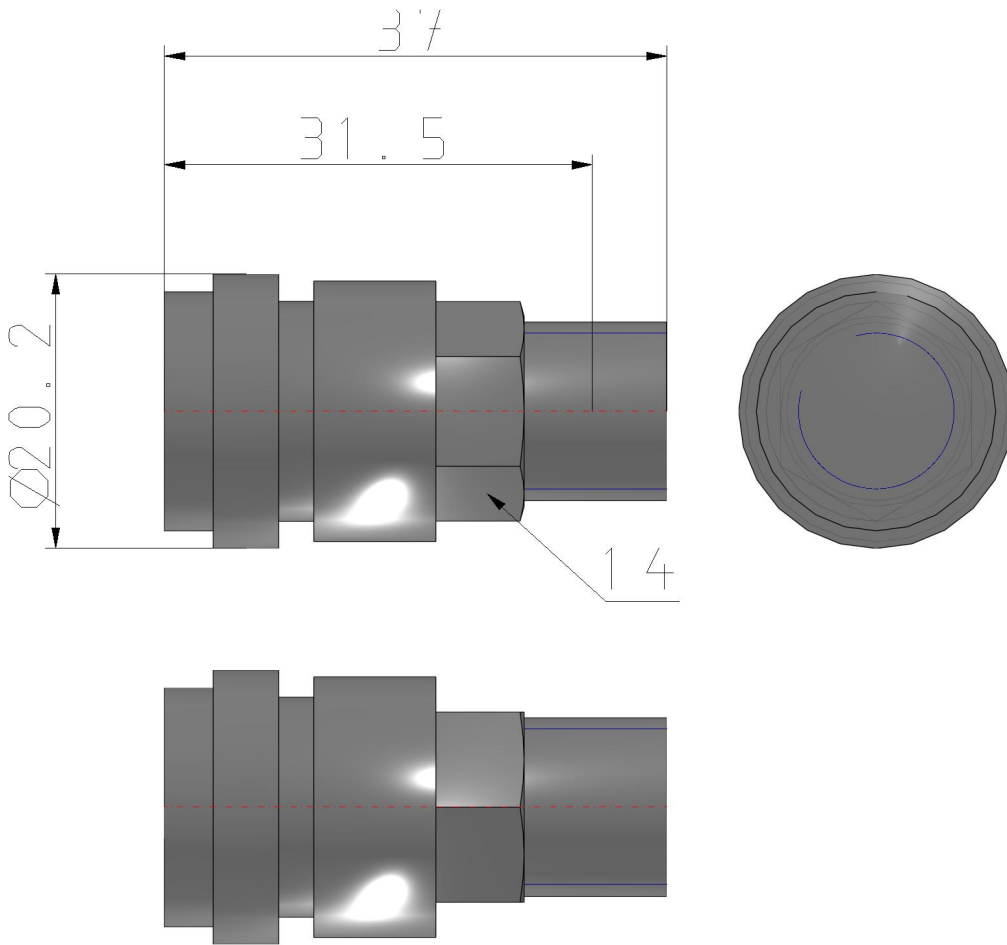

Additional information

Catalogue

[KK-C_EU.pdf](#)