

ANB1 High Noise Reduction Silencer - 38dB(A) ANB1-14

Datasheet

General series information

The high noise reduction style silencer ANA1 keeps the noise level inside a plant below 85dB(A) with a noise reduction effect of 40dB(A). Series ANB1 has a noise reduction effect of 38dB(A) and has a larger effective area with the same port size as series ANA1. It is also available for common exhaust from manifolds.

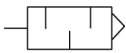

Silencer

Standard specifications

Model	ANB1-14 (Port Size 1 1/2)
Pressure medium	Compressed Air
Maximum temperature of pressure medium	60 °C
Minimum temperature of pressure medium	5 °C
Maximum ambient temperature	60 °C
Minimum ambient temperature	5 °C
Pneumatic input connection	R 1 1/2
Noise reduction	-38 dB (A)
Weight	0.950 Kg

Dimensions

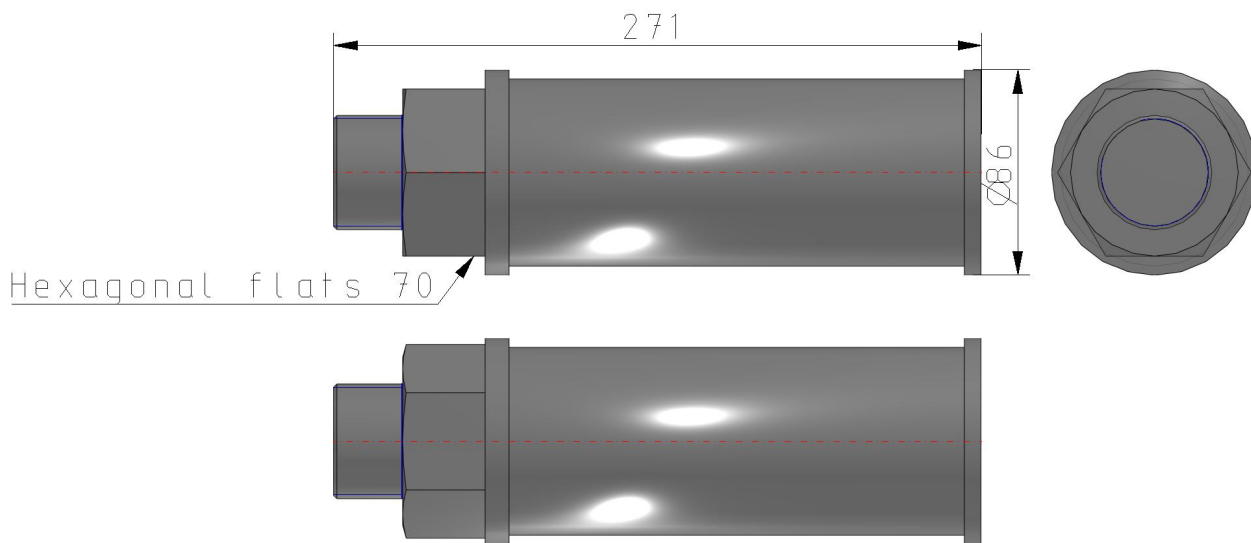

Additional information

Catalogue

[AN_EU.pdf](#)

Operation manuals

[OM_AMX_OM-D023EN-D.pdf](#)