

## ZH-A, Vacuum Ejector, Box Style/Body Ported Style, Metric

### ZH13BSA-08-10

Datasheet

### General series information

- One-touch fittings: Ø 6, 8, 10 and 12 mm. Screw-in connections: 1/8" to 1/2" (Rc/G).

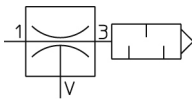

Vacuum ejector, with built-in silencer

### Standard specifications

Nozzle Diameter	13 (Ø 1.3 mm)
Model	B (Box Style)
Vacuum Pressure	S [-90 kPa; -89 kPa (Box Style)]
Port SUP.	08 (One-touch Fitting Ø8 mm)
Port VAC.	10 (One-touch Fitting Ø10)
Port EXH.	None
Accessories	W/ Bracket - W/o Silencer (or None in the Case of Box Style)
Pressure medium	Air
Maximum temperature of pressure medium	50 °C
Minimum temperature of pressure medium	-5 °C
Maximum ambient temperature	50 °C
Minimum ambient temperature	-5 °C
Pneumatic input connection	One-touch Ø 8
Flow rate	40 l/min (ANR)
Usable tubing material	Soft nylon;Nylon;Polyurethane
Pneumatic vacuum connection	One-touch Ø 10
Maximum Vacuum	-89 kPa
Nozzle nominal size [mm]	1.3 mm
Weight	0.027 Kg

# Dimensions

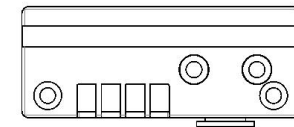
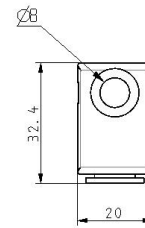
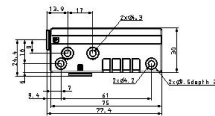
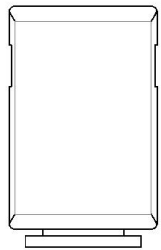
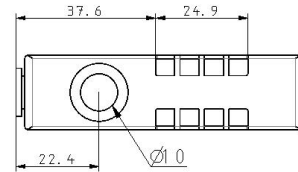

## Constructions

### Box type

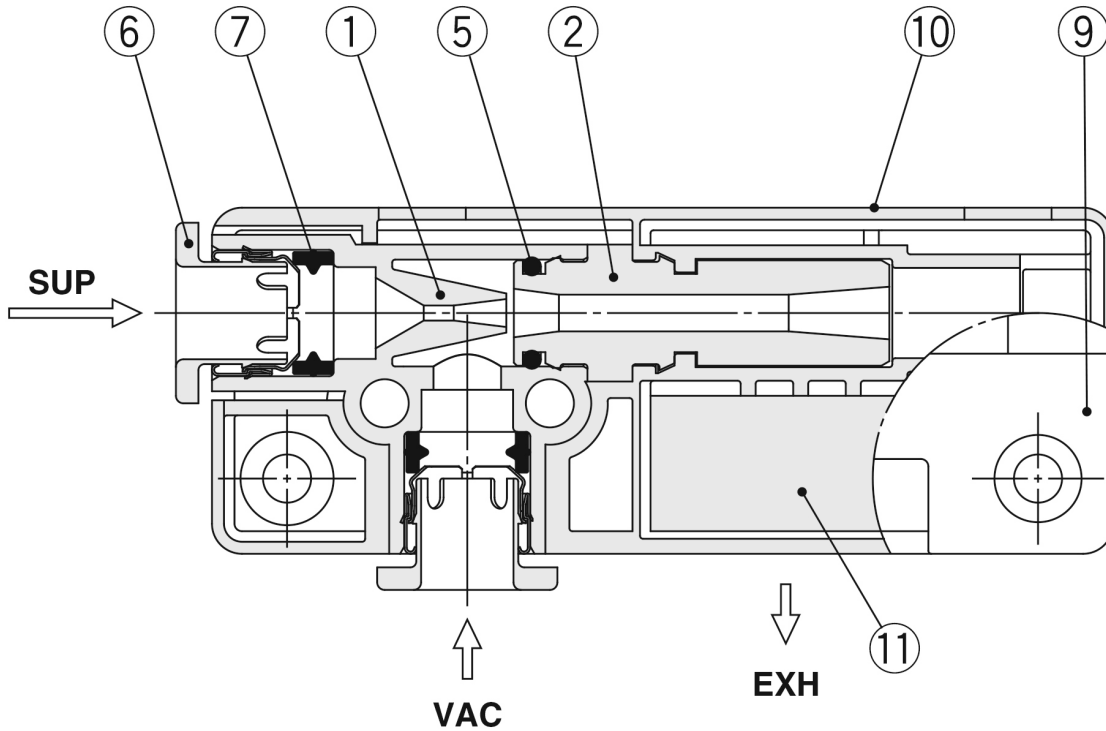

### Component Parts

No.	Description	Material	Note
1	Body	PBT	
2	Diffuser	PPS	Type S: Brown, Type L: Black
5	O-ring	NBR	Grease applied
6	Cassette	—	
7	Seal	NBR	Grease applied
9	Cover A	PBT	
10	Cover B	PBT	With identification mark for type S or type L (Refer to page 23 for details.)
11	Sound absorbing material	Resin	

## Additional information

Catalogue	<a href="#">ZH-C_EU.pdf</a>
Operation manuals	<a href="#">OM_ZH_OM00401EN.pdf</a>