

MHZ2, Air Gripper, Parallel Type, Standard MHZ2-6C

Datasheet

The MHZ2 series is a standard type parallel air gripper, taking the place of the MHQ(G)2 series. A linear guide provides high rigidity and high accuracy. MHZ2 can operate under higher pressure even at a larger holding point and overhang. High degree of mounting precision is achieved and mounting repeatability is improved.



Gripper, normally closed, single-acting with permanent magnet on piston

Standard specifications

Bore Size	6mm
Action	C (Single Acting N.C.)
Finger Position	Standard
Body Option	Basic
Auto Switch	No Switch
Lead Wire or Prewired Connector	0.5m (Or None in the Case of No Switch)
Number	2 pcs. (Or None in the Case of No Switch)
Pressure medium	Air
Maximum temperature of pressure medium	60 °C
Minimum temperature of pressure medium	-10 °C (No freezing)
Maximum operating pressure	0.7 MPa
Minimum operating pressure	0.3 MPa
Maximum ambient temperature	60 °C
Minimum ambient temperature	-10 °C (No freezing)
Conform to the European RoHS Directive	Conform
Pneumatic input connection	M3
Pneumatic exhaust connection	M3
Repeatability	± 0.01 mm
Lubrication	Non-lube
Type of gripper	Parallel
Number of pneumatic connections	1

Effective holding force per finger, internal (0.5 MPa)	3.7 N
Number of fingers	2
Mode of operation	Single acting, normally closed
Maximum operating frequency	180 c.p.m.
Opening / closing stroke (both sides)	4 mm
Weight	0.027 Kg

Dimensions

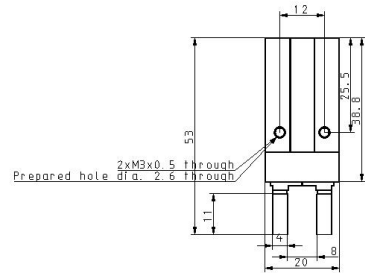
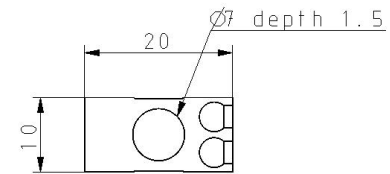
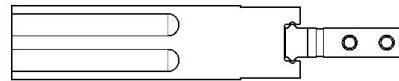
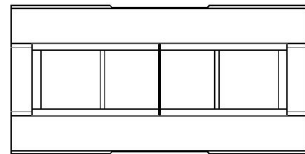
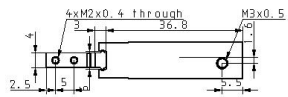
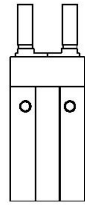

Constructions

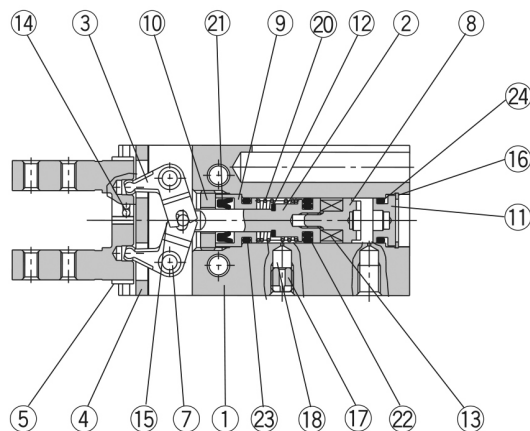
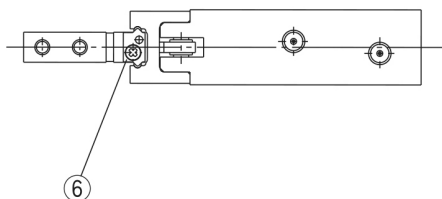

Parts list

No.	Description	Material	Note
1	Body	Aluminum alloy	Hard anodized
2	Piston	Stainless steel	
3	Lever	Stainless steel	Heat treated
4	Guide	Stainless steel	Heat treated
5	Finger	Stainless steel	Heat treated
6	Roller stopper	Stainless steel	
7	Lever shaft	Stainless steel	Nitrided
8	Magnet holder	Stainless steel	
9	Holder	Brass	Electroless nickel plated
10	Holder lock	Stainless steel	
11	Cap	Aluminum alloy	Clear anodized
12	Bumper	Urethane rubber	
13	Magnet	Rare earth magnet	Nickel plated

Parts list

No.	Description	Material	Note
14	Steel balls	High carbon chromium bearing steel	
15	Needle roller	High carbon chromium bearing steel	
16	C type snap ring	Carbon steel	Nickel plated
17	Exhaust plug	Brass	Electroless nickel plated
18	Exhaust filter	Polyvinyl formal	
20	N.C. spring	Stainless steel spring wire	
21	Rod seal	NBR	
22	Piston seal	NBR	
23	Gasket	NBR	
24	Gasket	NBR	

Additional information

Catalogue

[MHZ_EU.pdf](#)

Operation manuals

[OM_MHZ2_OMD0047EN.pdf](#)