

CXSL, Dual Piston Rods, Ball Bushing Bearing CXSL6-30

Datasheet

Series CXS is available in six bore sizes and stroke lengths up to 100mm. This series is very compact and has a very accurate non-rotating specification. It is suited for accurate pick-and-place applications or light duty material handling. The CXS can be used with either reed or solid state switches. Available in clean room versions.

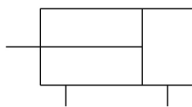

Double-acting, single-rod cylinder

Standard specifications

Thread port	M5 (Rc (PT) for sizes 25 to 32)
Bore Size	6mm
Lube-retainer	Without Stable Lubrication Function
Stroke	30mm
Auto Switch	No Switch
Lead Wire or Prewired Connector	0.5m [Or None in the Case of No Switch]
Number	2 pcs. [Or None in the Case of No Switch]
Pressure medium	Compressed Air
Maximum temperature of pressure medium with magnet	60 °C
Minimum temperature of pressure medium with magnet	-10 °C [without condensation]
Maximum operating pressure	0.70 MPa
Minimum operating pressure	0.15 MPa
Proof pressure	1.05 MPa
Maximum ambient temperature with magnet	60 °C
Minimum ambient temperature with magnet	-10 °C
Numero of pneumatic connections	2 pcs.
Pneumatic input connection	M5 x 0.8
Pneumatic output connection	M5 x 0.8
Mode of operation of drive	Double acting
Theoretical cylinder force, advance stroke (at 0.5 MPa)	28 N
Theoretical cylinder force, return stroke (at 0.5 MPa)	15 N

Maximum piston speed	300 mm/s
Type of cushioning	Rubber bumper
Maximum stroke reduction per side	5 mm
Tolerance of torsion	0.2°
Weight	0.108 Kg

Dimensions

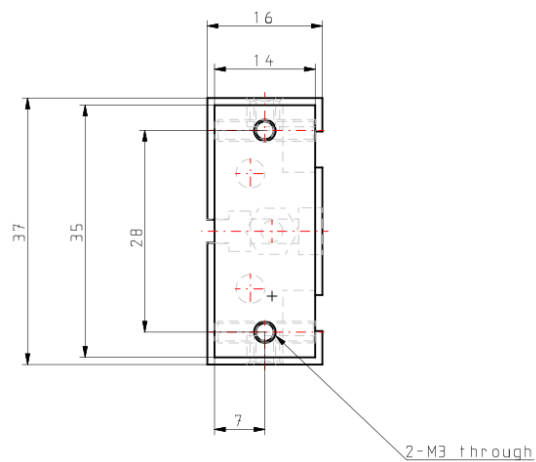
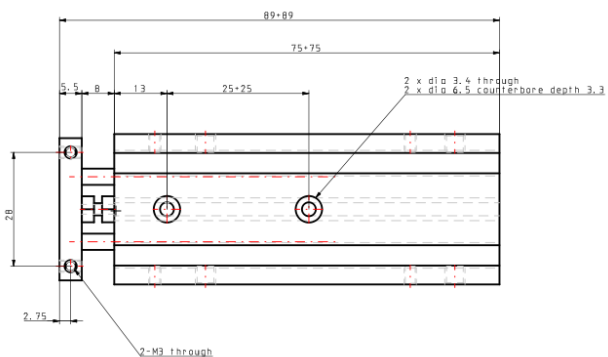
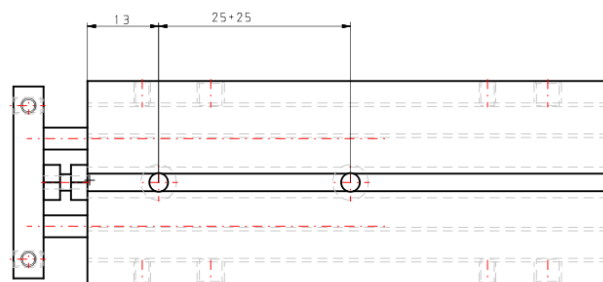
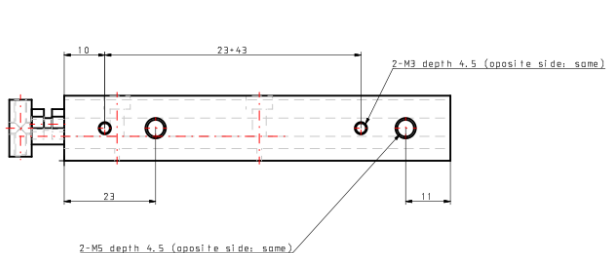

Constructions

CXSL6

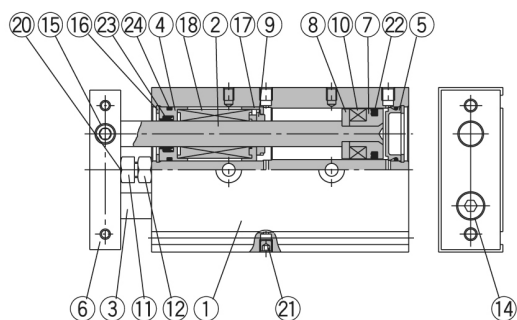
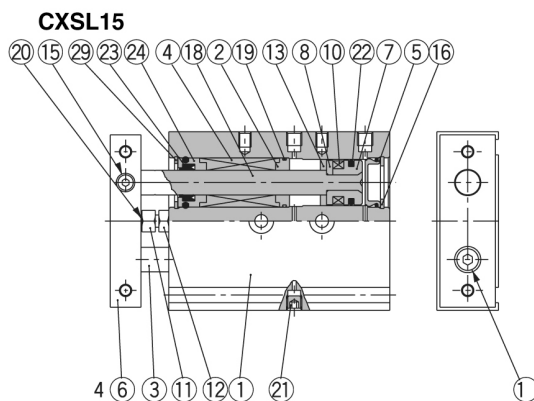
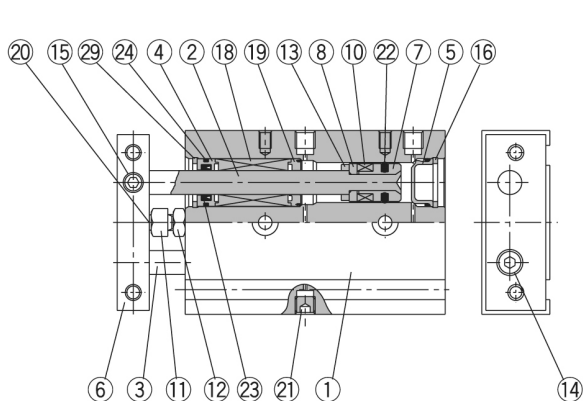
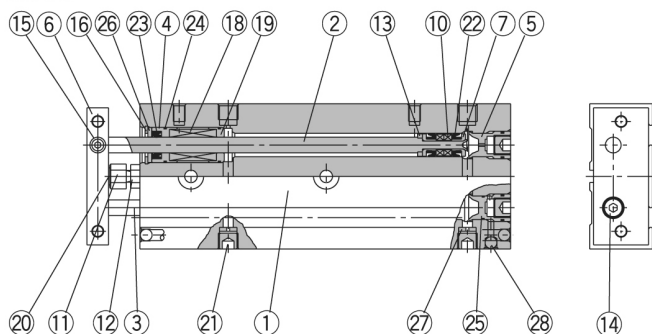

No.	Description	Material	Note
1	Housing	Aluminum alloy	Hard anodized
2	Piston rod A	Special steel	Hard chrome plated
3	Piston rod B	Special steel	Hard chrome plated
4	Rod cover/Bearing	Aluminum alloy	
5	Head cover	Special steel <small>Note 1)</small>	
6	Plate	Aluminum alloy	Hard anodized
7	Piston A	Aluminum alloy	Chromated
8	Piston B	Aluminum alloy	Chromated
9	Bumper A	Polyurethane	
10	Magnet	Magnetic material	
11	Bumper bolt	Carbon steel	Nickel plated
12	Hexagon nut	Carbon steel	Nickel plated
13	Bumper B	Polyurethane	
14	Hexagon socket head cap screw	Chromium steel	Nickel plated
15	Hexagon socket head set screw	Chromium steel	Nickel plated
16	Snap ring	Special steel	Nickel plated
17	Bumper holder	Synthetic resin	



Note 1) Anodized aluminum alloy for CXSL6.

Parts list

No.	Description	Material	Note
18	Ball bushing	—	
19	Bearing spacer	Synthetic resin <small>Note 2)</small>	
20	Bumper	Polyurethane	
21	Plug	Chromium steel	Nickel plated
22	Piston seal	NBR	
23	Rod seal	NBR	
24	O-ring	NBR	
25	Head cover B	Aluminum alloy	Nickel plated
26	Seal retainer	Aluminum alloy	
27	Port spacer	Aluminum alloy	
28	Steel ball	Special steel	Hard chrome plated
29	Snap ring B	Special steel	Nickel plated

Note 2) Aluminum alloy for CXSL6.

Additional information

Catalogue

[CXS_EU.pdf](#)