

AV2000/3000/4000/5000-A, Soft Start-up Valve AV3000-F03-5YB-A

Datasheet

General series information

- Power consumption: 0,35 W
- Improved flow rate characteristics: Up to 2,3 times C[dm³/ (s·bar)]: 9,2
- Energy saving: No air flow when the main valve is switched
- Improved adjustability at low speed air supply
- Smaller profile and less work hours due to integrated silencer.

Standard specifications

Body Size	3000
Thread	F (G)
Port Size	03 (3/8)
Option	None
Rated Voltage	5 (24 VDC)
Electrical Entry	Y (Type Y, DIN Terminal w/Connector)
Surge Suppressor	None
Manual Override	B (Push-locking slotted style)
Flow Direction/Pressure Unit	Flow direction: left to right
Pressure medium	Air
Maximum temperature of pressure medium	50 °C
Minimum temperature of pressure medium	0 °C
Maximum operating pressure	1 MPa
Minimum operating pressure	0.2 MPa
Proof pressure	1.5 MPa
Maximum ambient temperature	50 °C
Minimum ambient temperature	0 °C
Approvals	CE

Protection class with connector	Dust-protected (DIN terminal: IP65)
Pneumatic input connection	G 3/8
Pneumatic output connection	G 3/8
Pneumatic exhaust connection	G 3/8
Flow rate	3269 l/min (ANR)
Critical pressure ratio	0.27
Sonic conductance dm ³ /(s·bar)	13.1
Type of electrical connector	Type Y (DIN terminal/With connector)
Manual override	R 1/4
Weight	0.446 Kg

Dimensions

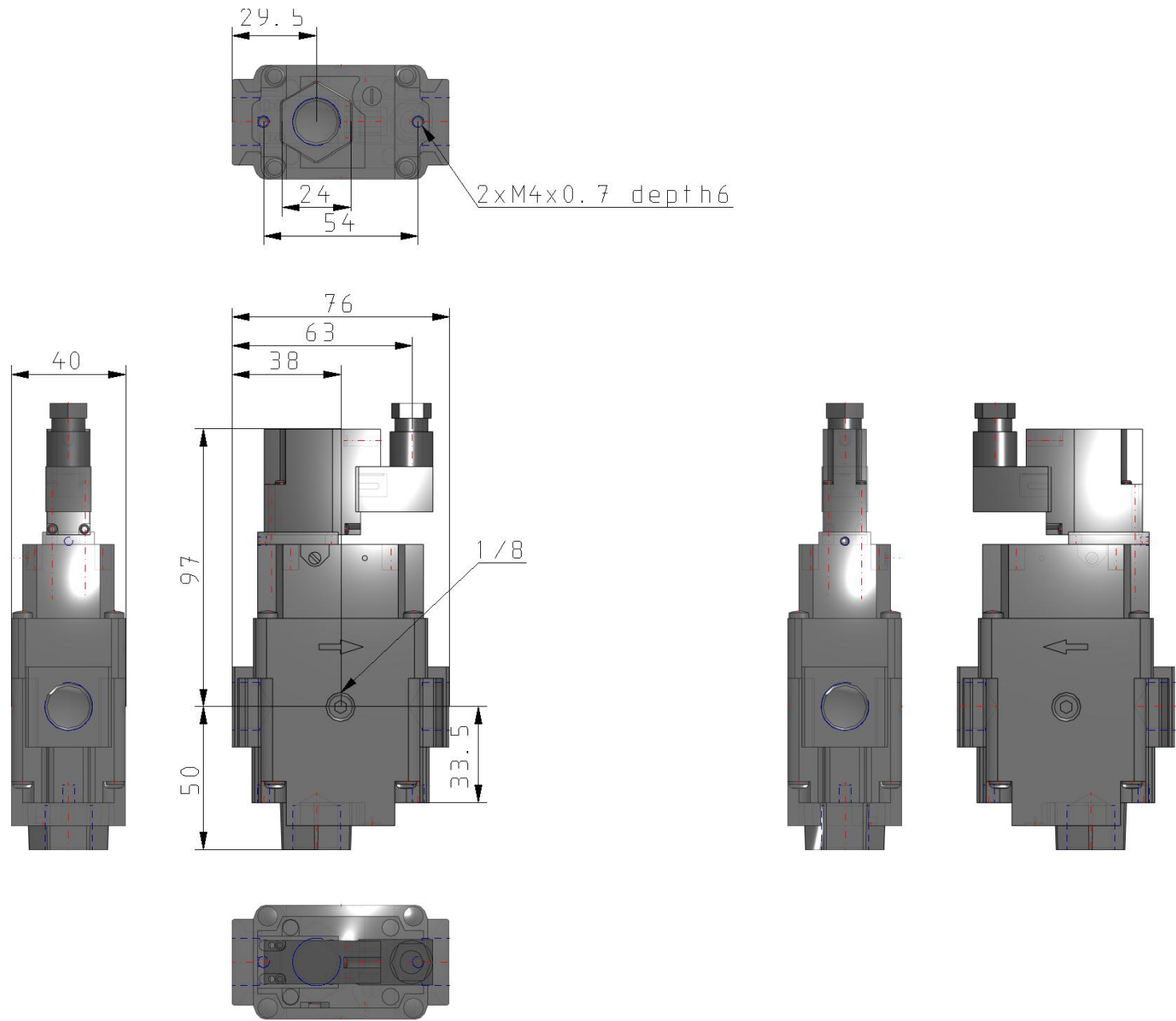

Specifications are subject to change without prior notice and any obligation on the part of the manufacturer.

Constructions

Construction

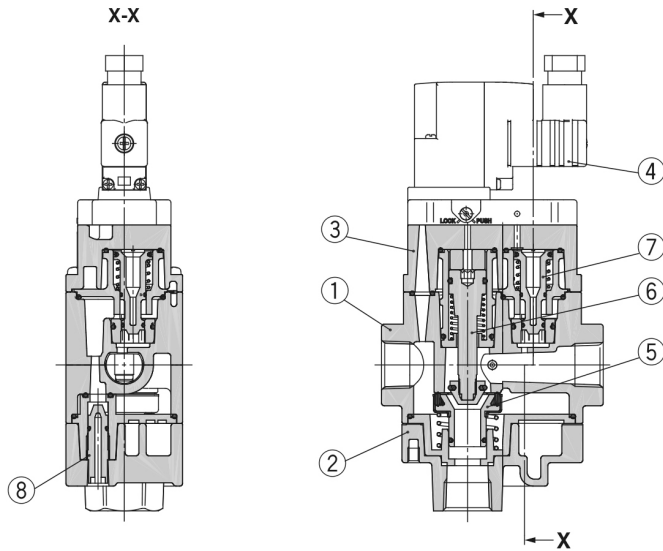

Component Parts

No.	Description	Material
1	Body	Aluminium die-cast
2	Bottom cover	Aluminium die-cast
3	Top cover	Aluminium die-cast

Replacement Parts

No.	Description	Material	AV2000-A	AV3000-A	AV4000-A	AV5000-A
4	Pilot valve assembly*1	—	See below.		See below.	
5	Valve assembly	Rubber material: HNBR	AV22P-060AS		AV42P-060AS	AV52P-060AS
6	Control valve assembly	—	AV22P-110AS		AV42P-110AS	AV52P-110AS
7	Piston assembly	POM, NBR	AV22P-120AS		AV42P-120AS	AV52P-120AS
8	Needle assembly	POM, NBR	AV22P-150AS	AV32P-150AS	AV42P-150AS	AV52P-150AS
9	Plug assembly	POM, NBR	AR22P-320AS-□01			

Additional information

Catalogue

[AV2-3-4-5000-A-B_EU.pdf](#)

Declaration of conformity

[newDoC_AV-A_TF1V02EN.pdf](#)

[newDoC_AV-A_TF122111EN.pdf](#)