

KK*P-*E, S-Couplers, Bulkhead Type with One-touch Fitting KK2P-06E

Datasheet

General series information

- Bulkhead Type with One-touch Fitting.
- Body size: M5, 1/8, 1/4, 1/2.
- Applicable Tubing O.D.: $\varnothing 3.2$, $\varnothing 4$, $\varnothing 6$, $\varnothing 8$, $\varnothing 10$, $\varnothing 12$, $\varnothing 16$.

Standard specifications

Body Size	2 (M5)
Applicable Tubing O.D.	$\varnothing 6$ mm
Pressure medium	Air, Water
Maximum operating pressure	1.0 MPa
Minimum operating pressure	-100 kPa
Proof pressure	1.5 MPa
Maximum ambient temperature	60 °C / 40 °C for Water
Minimum ambient temperature	-5 °C (with no freezing) / 5 °C for Water
Effective Area	3.8 mm ²
Sealing principle	Electroless nickel plated (copper-free application), With male thread sealant
Weight	0.009 Kg

Dimensions

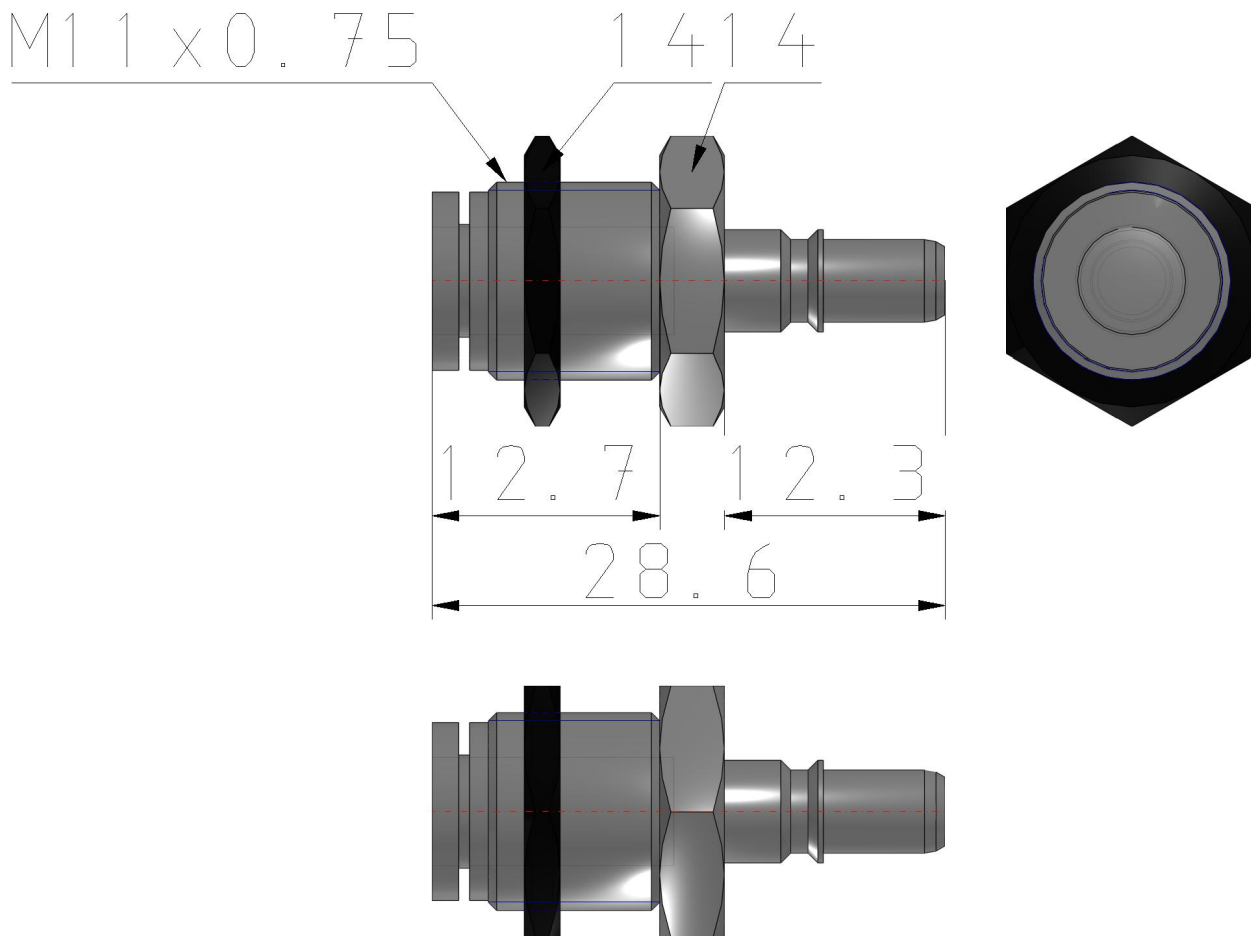

Additional information

Catalogue

[KK-C_EU.pdf](#)