

CQU Compact Cylinder, Plate Type, Double Acting, Single Rod CQUB20-20M

Datasheet

General series information

- Light and compact.
- Size: 20, 25, 32, 40.
- Stroke: 5 to 100 mm.
- Auto switch can be mounted without removing a support bracket.



Double-acting, single-rod cylinder

Standard specifications

Mounting	B [Through-hole/Both ends tapped common (Standard)]
Bore Size	20mm
Stroke	20mm
Rod End Thread	M (Male)
Auto Switch	No Switch
Lead Wire or Prewired Connector	0.5m (Or None in the Case of No Switch)
Number	2 pcs. (Or None in the Case of No Switch)
Maximum operating pressure	0.7 MPa
Minimum operating pressure	0.08 MPa
Proof pressure	1.0 MPa
Type of cushioning	Rubber Bumper
Fluid	Air
Ambient and fluid temperature	-10 - 70 °C
Stroke length tolerance	+1.4 0 mm
F450 - Mounting	Through-hole/Both ends tapped common
Piston speed	50 - 500 mm/s
Action	Double-acting, single-rod
Weight	0.170 Kg

Dimensions

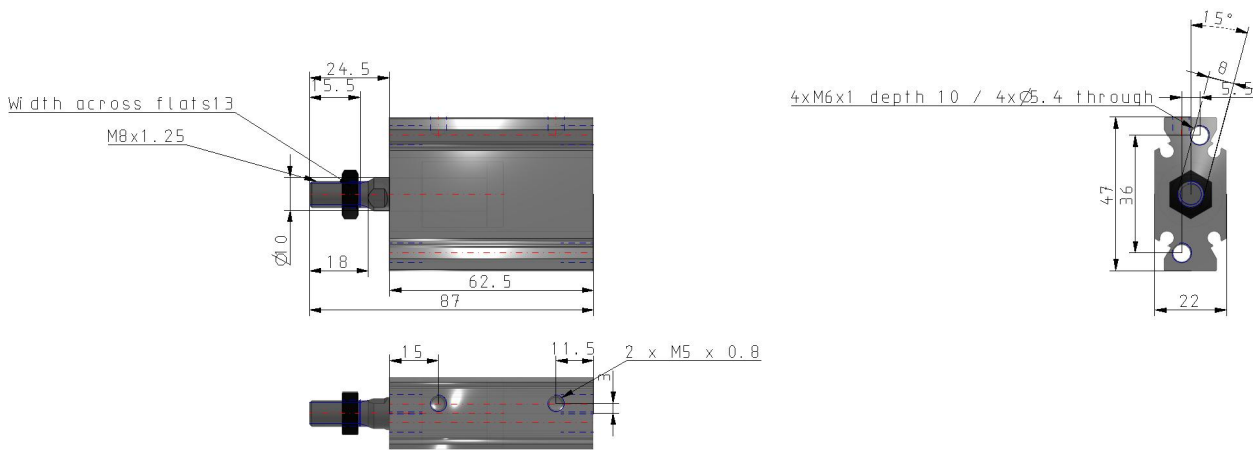

Constructions

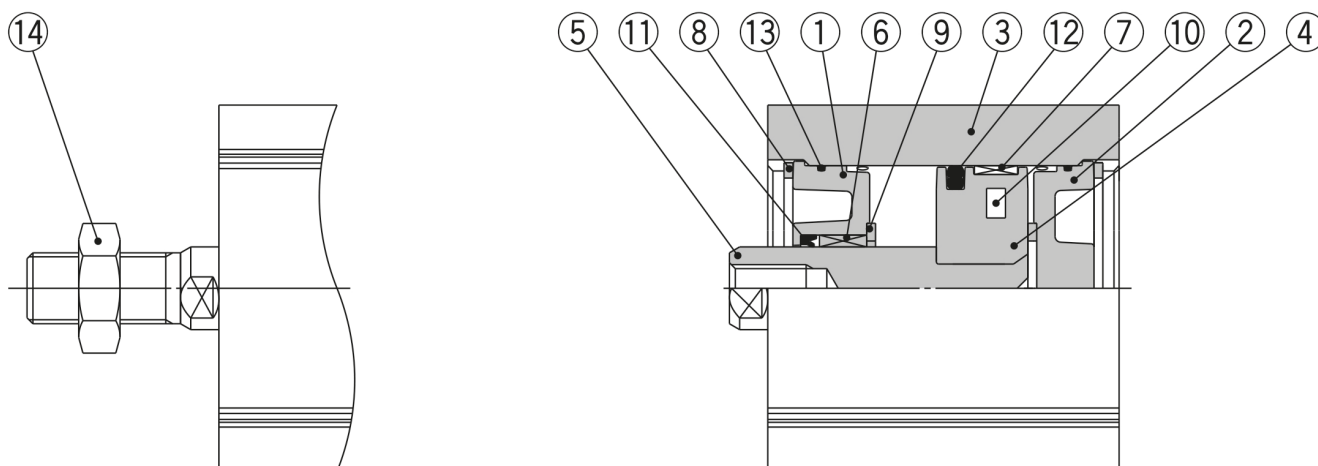

Rod end male thread

Component Parts

No.	Description	Material	Note
1	Rod cover	Aluminum die-casted	Chromated
2	Head cover	Aluminum die-casted	Chromated
3	Cylinder tube	Aluminum alloy	Hard anodized
4	Piston	Aluminum die-casted	Chromated
5	Piston rod	Carbon steel	Hard chrome plated
6	Bushing	Oil-impregnated sintered alloy	
7	Wear ring	Fluoropolymer	
8*	N-type retaining ring	Carbon tool steel	Phosphate coated
9	Bumper	Urethane	
10	Magnet	—	
11*	Rod seal	NBR	
12*	Piston seal	NBR	
13*	O-ring	NBR	Nickel plated
14	Rod end nut	Carbon steel	

Additional information

Catalogue

[CQU-A_EU.pdf](#)