

RS(D)Q-Z, Stopper Cylinder, Fixed Mounting Height RSDQB32TF-20DZ

Datasheet

General series information

- Fixed Height Stopper Cylinder, Double / Single Acting
- Bore sizes (mm): 16, 20, 32, 40, 50
- Strokes up to 30 mm
- 10 rod end configurations available
- Compact auto switch mountable on 4 surfaces.

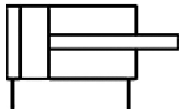

Double acting cylinders

Standard specifications

Magnet	D (Built-in)
Mounting	B (Through Hole, Standard)
Bore Size	32mm
Port Thread	TF (Bore 20: M5 Thread, Bore 32 to 50: G)
Stroke	20mm
Action	D (Double Acting)
Rod End	Round Bar Style
Mounting Bolt	None
Auto Switch	No Switch
Lead Wire or Prewired Connector	0.5m (Or None in the Case of No Switch)
Number	2 pcs. (Or None in the Case of No Switch)
Made to Order	None
Pressure medium	Air
Maximum operating pressure	1.0 MPa
Proof pressure	1.5 MPa
Maximum ambient temperature with magnet	60 °C
Minimum ambient temperature with magnet	-10 °C
Maximum piston speed	500 mm/s

Type of cushioning	Rubber bumper
Minimum piston speed	50 mm/s
Lubrication	Not required (Non-lube)
Stroke length tolerance	+1.4 0
Weight	0.411 Kg

Specifications are subject to change without prior notice and any obligation on the part of the manufacturer.

Dimensions

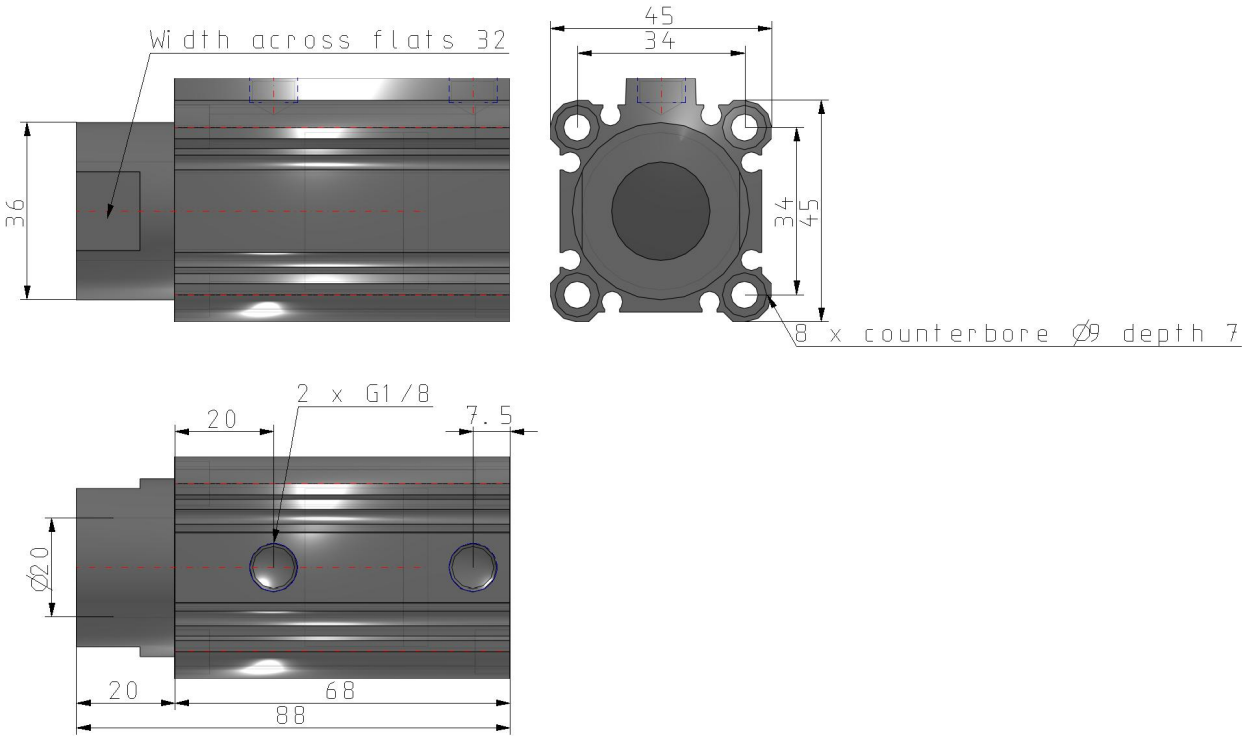

Constructions

Rod end configuration:

Round bar (—)

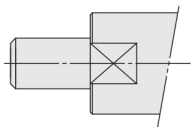

Round bar with female thread (F)

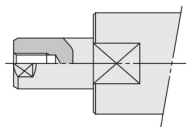

Chamfered (K)

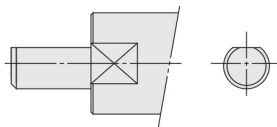

Chamfered with female thread (G)

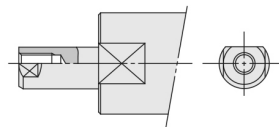

Lever (Fixed absorber type)

($\varnothing 32$, $\varnothing 40$, $\varnothing 50$ only)

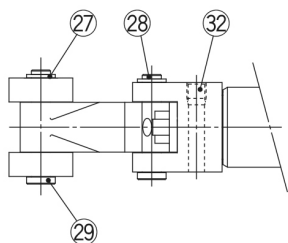
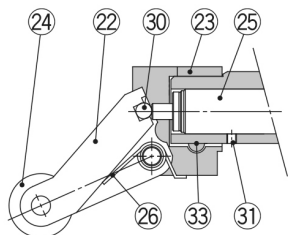

Lever (Adjustable absorber type)

($\varnothing 32$, $\varnothing 40$, $\varnothing 50$ only)

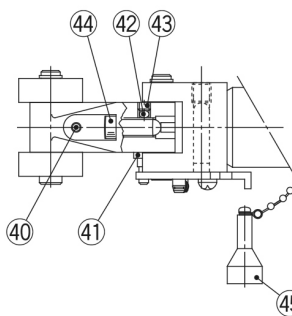
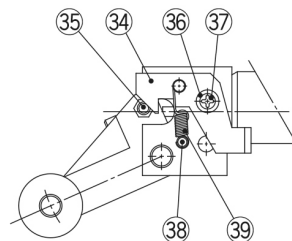

Only one roller is provided for $\varnothing 32$.

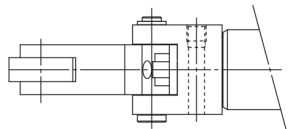

Component Parts

No.	Description	Material
22	Lever	Cast iron
23	Lever holder	Rolled steel
24	Roller B	Resin
25	Shock absorber	—
26	Lever spring	Stainless steel wire
27	C retaining ring for axis	Carbon tool steel
28	Lever pin	Carbon steel
29	Roller pin	Carbon steel
30	Steel ball	High carbon chrome bearing steel
31	Hexagon socket head set screw	Chromium molybdenum steel
32	Hexagon socket head set screw	Chromium molybdenum steel
33	One-side tapered pin	Carbon steel

No.	Description	Material
34	Bracket	Carbon steel
35	Pin B	Carbon steel
36	Spacer	Carbon steel
37	Cross recessed round head screw	Rolled steel
38	Pin A	Rolled steel
39	Bracket spring	Steel wire
40	Hexagon socket head set screw	Chromium molybdenum steel
41	Spring washer	Steel wire
42	Urethane ball	Urethane
43	Hexagon socket head set screw	Chromium molybdenum steel
44	Adjustment bolt	Bearing steel
45	Cancel cap	Aluminium alloy

Additional information

Catalogue

[RSQ-A_EU.pdf](#)

Operation manuals

[OM_RSQ_OM0080EN-Q.pdf](#)