

## C(D)Q2, Compact Cylinder, Double Acting, Single Rod w/Auto Switch Mounting Groove CQ2B80TF-15DZ

Datasheet

### General series information

- Double acting, single rod, compact cylinder
- Bore sizes (mm): 12, 16, 20, 25, 32, 40, 50, 63, 80, 100
- Standard stroke range (mm): 5 to 100
- Port threads: M (12 to 25 bore); Rc, NPT or G (32 to 100 bore)
- Can mount small auto switches on 4 surfaces.



### Standard specifications

Magnet	None
Mounting	B (Through Hole [Standard])
Type	Standard
Bore Size	Ø80 mm
Port Thread Type	TF
Lube-retainer	Without Stable Lubrication Function
Stroke	15
Body Option	Standard [Rod End Female Thread]
Auto Switch Groove	Z [Auto Switch Mounting Grooves]
Mounting Bolt	None
Rod End Bracket	None
Auto Switch	No Switch
Lead Wire or Prewired Connector	0.5 m or None in the Case of No Switch
Number	2 pcs.
Rod End Options	None
Temperature Resistance	None
Low Speed	None
Made of Stainless Steel	None

Fluororubber Seal	None
Pressure medium	Compressed air
Maximum temperature of pressure medium	70 °C
Minimum temperature of pressure medium	-10 °C
Maximum operating pressure	1.0 MPa
Minimum operating pressure	0,05 Mpa
Proof pressure	1.5 MPa
Maximum ambient temperature	70 °C
Minimum ambient temperature	-10 °C
Number of pneumatic connections	2 pcs.
Pneumatic input connection	G 3/8
Mode of operation of drive	Double acting
Theoretical cylinder force, advance stroke (at 0.5 MPa)	2510N
Theoretical cylinder force, return stroke (at 0.5 MPa)	2270 N
Maximum piston speed	500 mm/s
Geometric form of the piston rod	Single rod
Male thread of rod end	M22 x 1.5
Female thread of rod end	M16 x 2.0
Minimum piston speed	50 mm/s
Weight	0.976 Kg

# Dimensions

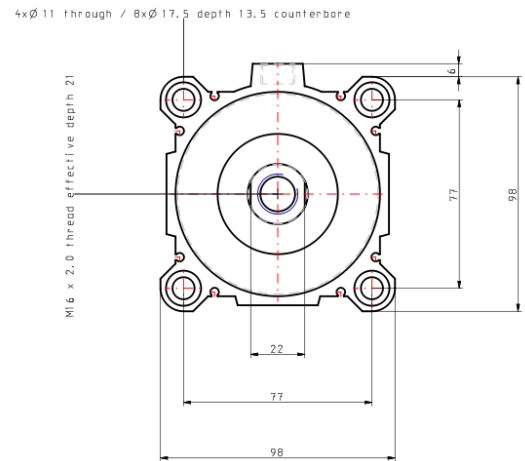
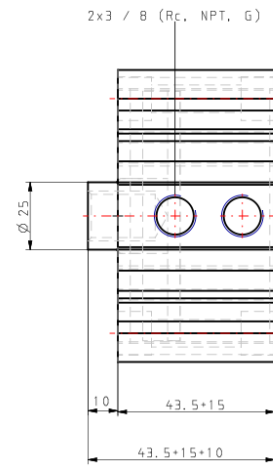

## Constructions

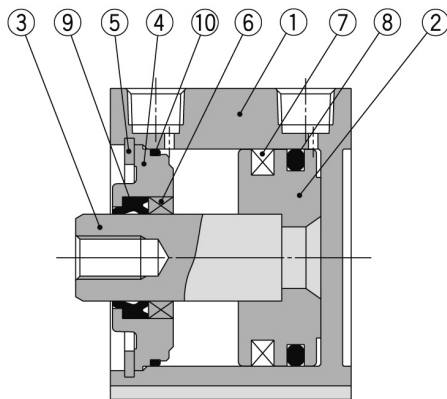

### Component Parts

No.	Description	Material	Note
1	<b>Cylinder tube</b>	Aluminum alloy	Hard anodised
2	<b>Piston</b>	Aluminum alloy	Chromated
3	<b>Piston rod</b>	Stainless steel	ø12 to ø25
		Carbon steel	ø32 to ø100, Hard chrome plated
4	<b>Collar</b>	Aluminum alloy	ø12 to ø40, Anodised
		Aluminum alloy casted	ø50 to ø100, Chromated, Painted
5	<b>Retaining ring</b>	Carbon tool steel	Phosphate coated
6	<b>Bushing</b>	Bearing alloy	For ø50 or more only
7	<b>Magnet</b>	—	
8	<b>Piston seal</b>	NBR	
9	<b>Rod seal</b>	NBR	
10	<b>Gasket</b>	NBR	

### Replacement Parts/Seal Kit (Pneumatic type)

Bore size (mm)	Kit no.	Contents
12	CQ2B12-PS	Kits include items ⑧, ⑨, ⑩ from the table.
16	CQ2B16-PS	
20	CQ2B20-PS	
25	CQ2B25-PS	
32	CQ2B32-PS	
40	CQ2B40-PS	
50	CQ2B50-PS	
63	CQ2B63-PS	
80	CQ2B80-PS	
100	CQ2B100-PS	

- \* Seal kit includes ⑧, ⑨, ⑩. Order the seal kit, based on each bore size.
- \* Since the seal kit does not include a grease pack, order it separately.

**Grease pack part no.: GR-S-010 (10 g)**

### Replacement Parts/Seal Kit (Air-hydro type)

Bore size (mm)	Kit no.	Contents
20	CQ2BH20-PS	Kits include items ⑧, ⑨, ⑩ from the table.
25	CQ2BH25-PS	
32	CQ2BH32-PS	
40	CQ2BH40-PS	
50	CQ2BH50-PS	
63	CQ2BH63-PS	
80	CQ2BH80-PS	
100	CQ2BH100-PS	

- \* Seal kit includes ⑧, ⑨, ⑩. Order the seal kit, based on each bore size.
- \* Since the seal kit does not include a grease pack, order it separately.

**Grease pack part no.: GR-S-010 (10 g)**

## Additional information

Catalogue

[CQ2-Z-C\\_EU.pdf](#)