

## AW20-D to AW60-D, Filter Regulator & Filter Regulator w/Backflow Function AW40K-F04E-D

Datasheet

### General series information

- ISO 8573-1:2010 compliant
- Maximum flow rate up to 17600 l/min (ANR, 0.7MPa).

### Standard specifications

Body Size	40
Backflow Function	K (w/Backflow Function)
Thread	F (G)
Port Size	04 (1/2)
Options	E [w/Square Embedded Type Pressure Gauge (w/Limit Indicator)]
Set pressure	0.05 to 0.85 MPa Setting
Bowl	Polycarbonate Bowl
Drain Guide	Standard
Exhaust Mechanism	Relieving
Flow Direction	Left to Right
Drain Cock w/Barb Fitting	None
Pressure Units	Standard (Name Plate, Caution Plate for Bowl, and Pressure Gauge: MPa)
Pressure medium	Air
Maximum temperature of pressure medium	60 °C
Minimum temperature of pressure medium	-5 °C (with no freezing)
Maximum ambient temperature	60 °C
Minimum ambient temperature	-5 °C (with no freezing)
Grade of filtration	5 µm
Weight	0.632 Kg

# Dimensions

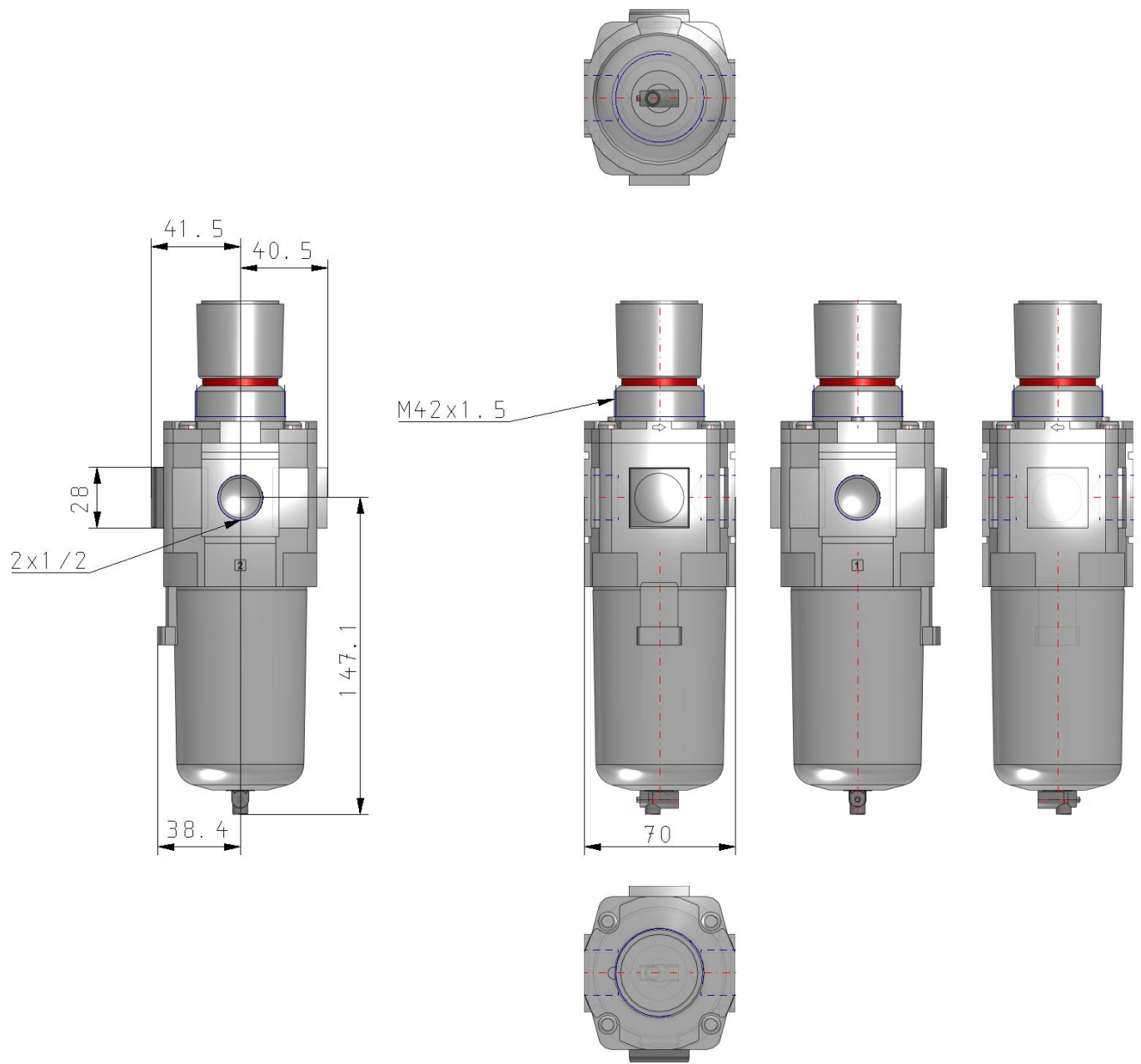

Specifications are subject to change without prior notice and any obligation on the part of the manufacturer.

## Additional information

Catalogue

[ACD-D\\_EU.pdf](#)

Operation manuals

[OM\\_AW20-60-D\\_OMX0057EN-B.pdf](#)