

AR20-D to AR60-D, Regulator & Regulator w/Backflow Function AR30-F03G-D

Datasheet

General series information

- ISO 8573-1:2010 compliant
- Up to 0.85 MPa set pressure
- Maximum flow rate up to 20000 l/min (ANR, 0.7MPa).

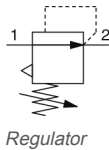

Standard specifications

Body Size	30
Backflow Function	None
Thread	F (G)
Port Size	03 (3/8)
Options	G (Round Pressure Gauge w/Limit Indicator)
Set pressure	0.05 to 0.85 MPa Setting
Exhaust Mechanism	Relieving
Flow Direction	Left to Right
Knob	Downward
Pressure Units	Standard (Name Plate, Caution Plate for Bowl, and Pressure Gauge: MPa)
Construction	Relieving type
Pressure medium	Air
Maximum temperature of pressure medium	60 °C
Minimum temperature of pressure medium	-5 °C (with no freezing)
Maximum operating pressure	1.0 MPa
Proof pressure	1.5 MPa
Maximum ambient temperature	60 °C
Minimum ambient temperature	-5 °C (with no freezing)
Weight	0.330 Kg

Dimensions

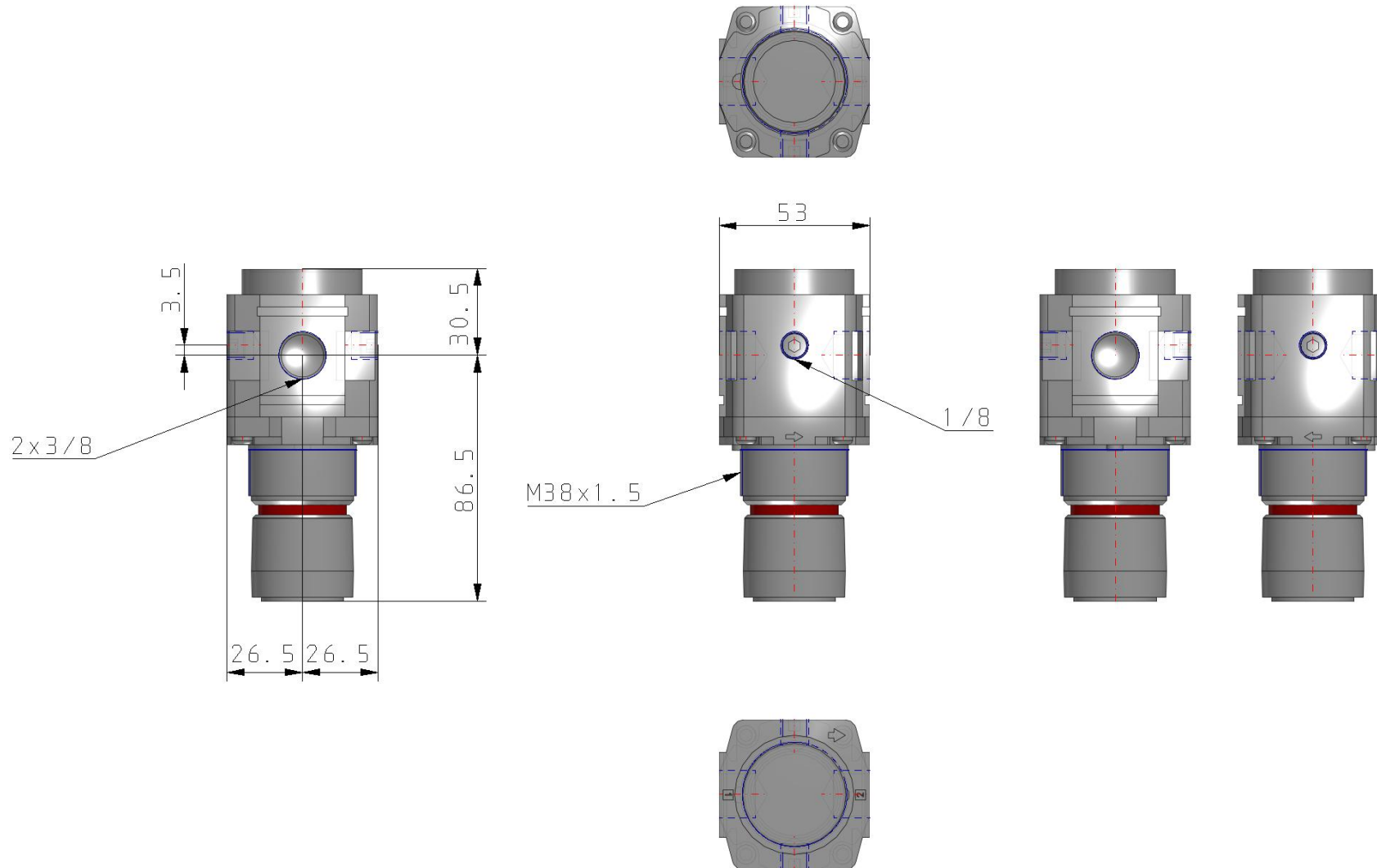

Additional information

Catalogue	ACD-D_EU.pdf
Installation manuals	IM_ARx-D_TF2Z352EN.pdf
Operation manuals	OM_AR20-60-D_OMX0055EN-B.pdf