

## In-line - AS\*2F-A AS1002F-06A

### Datasheet

### General series information

- Applicable Tubing O.D.: Ø 3.2 to Ø 12 mm and Ø 1/8" to Ø 1/2"
- Operating Pressure Range: 0.1 to 1 MPa.

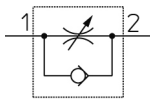

Flow control valve, adjustable, with reverse free flow

### Standard specifications

Body Size	100 (M5 Standard)
Applicable Tube O.D.	06 (ø6)
Pressure medium	Air
Maximum operating pressure	1 MPa
Minimum operating pressure	0.1 MPa
Proof pressure	1.5 MPa
Maximum ambient temperature	60 °C
Minimum ambient temperature	-5 °C
Applicable tubing material	Nylon, Soft nylon, Polyurethane, FEP, PFA
Weight	0.007 Kg



## Constructions

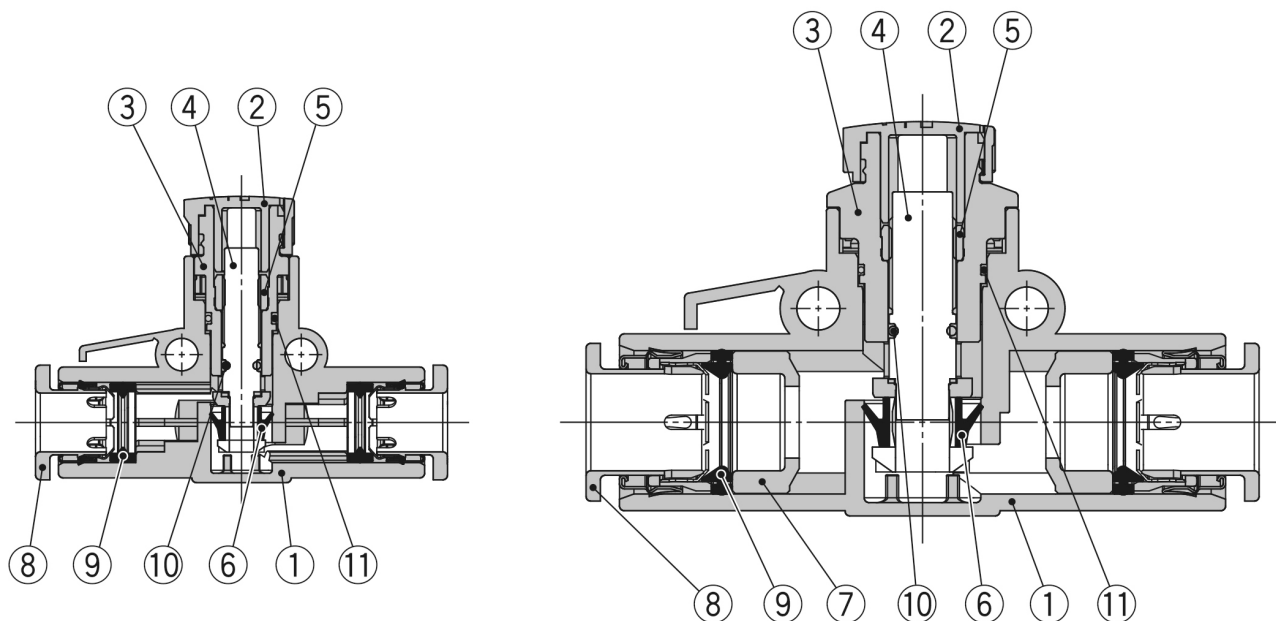

### Component Parts

No.	Description	Material	Note
1	<b>Body A</b>	PBT	
2	<b>Knob</b>	POM	
3	<b>Body B</b>	PBT	
4	<b>Needle</b>	PBT	
5	<b>Needle guide</b>	Brass	Electroless nickel plating
6	<b>U-seal</b>	HNBR	
7	<b>Spacer</b>	PBT*1	
8	<b>Cassette</b>	—	
9	<b>Seal</b>	NBR	
10	<b>O-ring</b>	NBR	
11	<b>O-ring</b>	NBR	

\*1 The AS3002F-11A, AS4002F-11A, AS4002F-13A are made of electroless nickel plated brass.

## Additional information

Catalogue

[AS-B\\_in-line\\_EU.pdf](#)