

MGP-AZ, Compact Guide Cylinder, Air Cushion MGPM40TF-50AZ

Datasheet

General series information

- With Air Cushion.
- 3 types of bearing can be selected: slide bearing, ball bushing and high precision ball bushing.
- Compactness & Lightness
- Bore size: 16, 20, 25, 32, 40, 50, 63, 80, 100 (mm)
- Strokes from 10 to 400mm (depending upon bore size)
- Auto switches can be mounted on 2 surfaces.



Double-acting, single-rod cylinder

Standard specifications

Bearing Type	M (Slide Bearing)
Bore Size	Ø40 mm
Port Thread Type	TF [G]
Stroke	50 mm
Auto Switch	No Switch
Lead Wire or Prewired Connector	0.5m [Or None in the Case of No Switch]
Number	2 pcs. [Or None in the Case of No Switch]
Made to Order	None
Pressure medium	Air
Maximum temperature of pressure medium	60 °C
Minimum temperature of pressure medium	-10 °C (No freezing)
Maximum operating pressure	1.0 MPa
Minimum operating pressure	0.12 MPa
Proof pressure	1.5 MPa
Maximum ambient temperature	60 °C
Maximum ambient temperature with magnet	-10 °C (No freezing)
Number of pneumatic connections	4 pcs.

Pneumatic input connection	G 1/8
Pneumatic output connection	G 1/8
Mode of operation of drive	Double acting
Theoretical cylinder force, advance stroke (at 0.5 MPa)	628 N
Theoretical cylinder force, return stroke (at 0.5 MPa)	551 N
Maximum piston speed	500 mm/s
Type of cushioning	Air cushion on both ends (Without bumper)
Non-rotating accuracy of plate	$\pm 0.05^\circ$
Weight	2.562 Kg

Dimensions

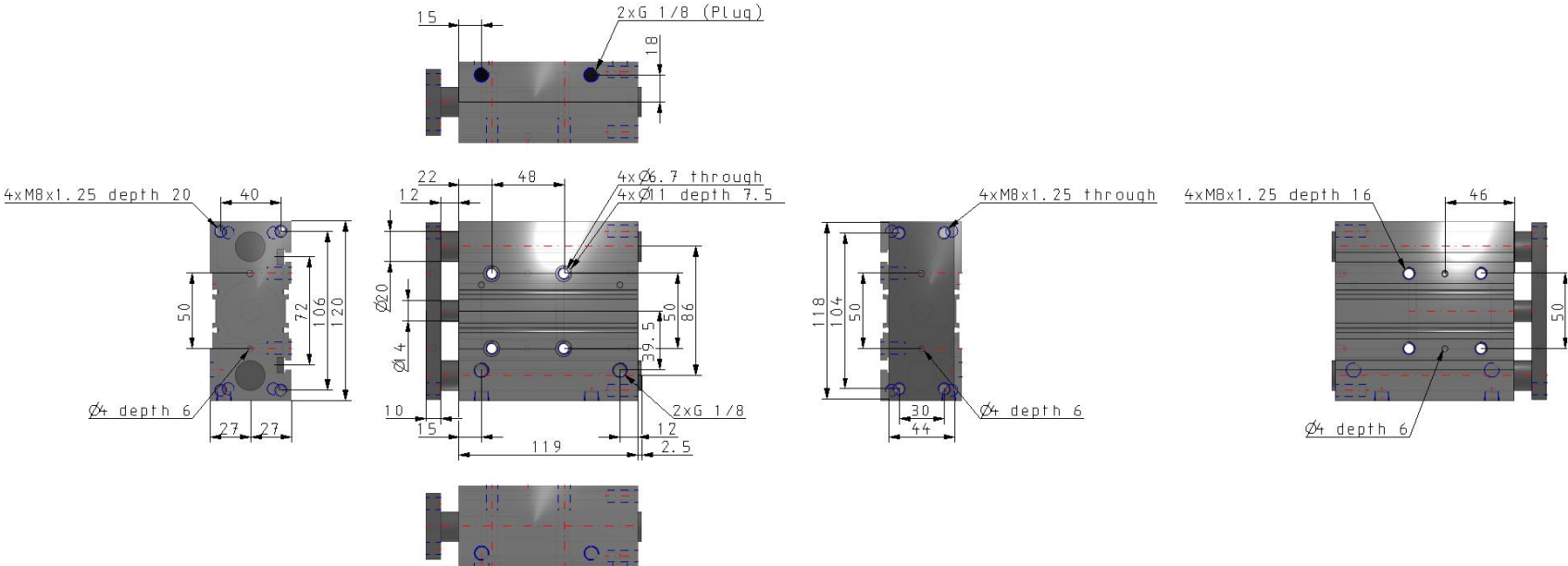

Constructions

MGPM

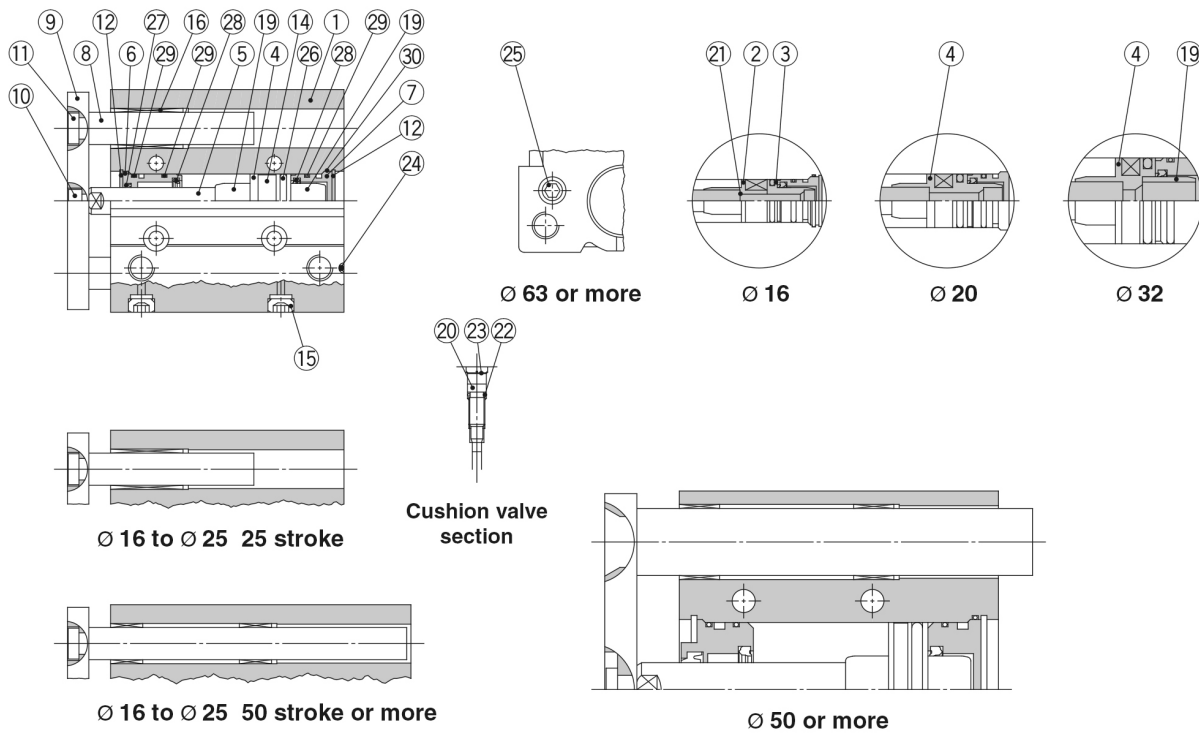

Component Parts

No.	Description	Material	Note
1	Body	Aluminium alloy	Hard anodised
2	Piston A	Aluminium alloy	Ø 16
3	Piston B	Aluminium alloy	Ø 16
4	Piston	Aluminium alloy	Ø 20 to Ø 100
5	Piston rod	Stainless steel	Ø 16 to Ø 25
		Carbon steel	Ø 32 to Ø 100 Hard chrome plating
6	Collar	Aluminium alloy	Chromated
7	Head cover	Aluminium alloy	Chromated
8	Guide rod	Carbon steel	Hard chrome plating
9	Plate	Carbon steel	Nickel plating
10	Plate mounting bolt	Carbon steel	Nickel plating
11	Guide bolt	Carbon steel	Nickel plating
12	Retaining ring	Carbon tool steel	Phosphate coated
13	Retaining ring	Carbon tool steel	Phosphate coated
14	Magnet	—	
15	Plug Hexagon socket head plug	Carbon steel	Ø 16
			Ø 20 to Ø 100
16	Slide bearing	Bearing alloy	
17	Ball bushing	—	
18	Spacer	Aluminium alloy	
19	Cushion ring	Aluminium alloy	Ø 25 to Ø 100 Anodised
20	Cushion valve		Ø 16 to Ø 32
			Ø 50 to Ø 100
			Electroless nickel plating
	Cushion needle		Ø 40 only Electroless nickel plating

*: A felt is not installed on the slide bearing.

Component Parts

No.	Description	Material	Note
21	Gasket	NBR	Ø 16
22	Gasket	NBR	
23	Retaining ring	Carbon tool steel	Ø 50, Ø 63 Phosphate coated
24	Steel ball	Carbon steel	Ø 16 to Ø 50
25	Plug	Carbon steel	Ø 63 to Ø 100 Nickel plating
26*	Piston seal	NBR	
27*	Rod seal	NBR	
28*	Cushion seal	Urethane	
29*	Gasket A	NBR	
30*	Gasket B	NBR	

Replacement Parts/Seal Kit

Bore size [mm]	Kit no.	Contents	Bore size [mm]	Kit no.	Contents
16	MGP16-AZ-PS	Set of nos. above 26, 27, 28, 29, 30	50	MGP50-AZ-PS	Set of nos. above 26, 27, 29, 29, 30
20	MGP20-AZ-PS		63	MGP63-AZ-PS	
25	MGP25-AZ-PS		80	MGP80-AZ-PS	
32	MGP32-AZ-PS		100	MGP100-AZ-PS	
40	MGP40-AZ-PS				

*: Seal kit includes 26 to 30. Order the seal kit, based on each bore size.

*: Since the seal kit does not include a grease pack, order it separately.

Grease pack part no.: GR-S-010 (10 g)

Additional information

Catalogue

[MGP-Z-Dd_EU.pdf#page=30](#)

Operation manuals

[OM_MGP-Z_MGPx-OM0047PEN-B.pdf](#)