

Standard - MHZ2 MHZ2-10SN

Datasheet

General series information

- Maximum gripping force per finger 43.5 N at 0.5 MPa
- Double acting and single acting
- Repeatability: ± 0.01 mm
- Max. operating frequency: 180 c.p.m.



Gripper, normally open, single-acting with permanent magnet on piston

Standard specifications

Bore Size	10mm
Action	S (Single Acting N.O.)
Finger Position	N (Narrow Type)
Body Option	Basic
Auto Switch	No Switch
Lead Wire or Prewired Connector	0.5m (Or None in the Case of No Switch)
Number	2 pcs. (Or None in the Case of No Switch)
Pressure medium	Air
Maximum temperature of pressure medium	60 °C
Minimum temperature of pressure medium	-10 °C (No freezing)
Maximum operating pressure	0.7 MPa
Minimum operating pressure	0.35 MPa
Maximum ambient temperature	60 °C
Minimum ambient temperature	-10 °C (No freezing)
Pneumatic input connection	M3
Pneumatic exhaust connection	M3
Repeatability	± 0.01 mm
Lubrication	Non-lube
Type of gripper	Parallel

Number of pneumatic connections	1
Effective holding force per finger, external (0.5 MPa)	7.1 N
Number of fingers	2
Mode of operation	Single acting, normally open
Maximum operating frequency	180 c.p.m.
Opening / closing stroke (both sides)	4 mm
Weight	0.055 Kg

Dimensions

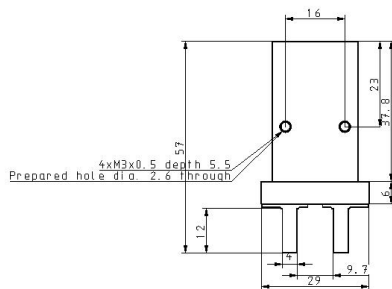
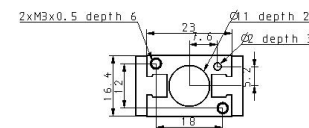
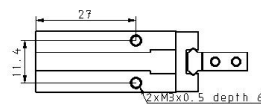
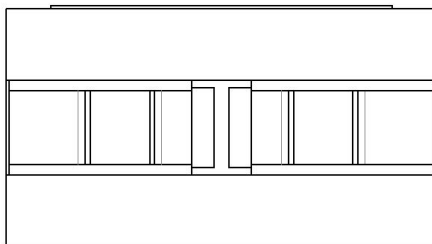
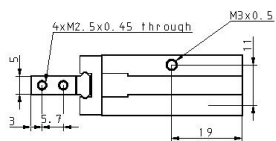
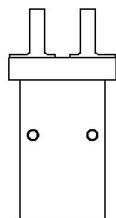

Constructions

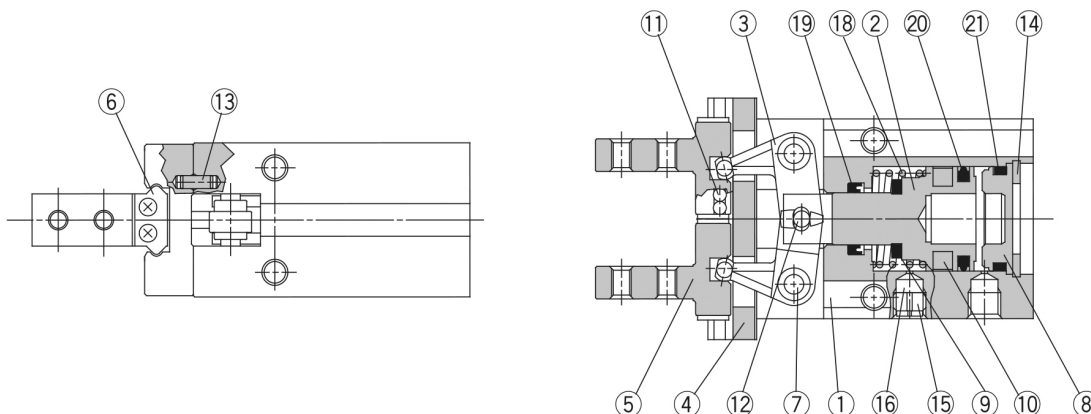

Parts list

No.	Description	Material	Note
1	Body	Aluminum alloy	Hard anodized
2	Piston	ø10, ø16: Stainless steel ø20 to ø40: Aluminum alloy	ø20 to ø40: Hard anodized
3	Lever	Stainless steel	Heat treated
4	Guide	Stainless steel	Heat treated
5	Finger	Stainless steel	Heat treated
6	Roller stopper	Stainless steel	
7	Lever shaft	Stainless steel	Nitrided
8	Cap	ø10 to ø25: Synthetic resin ø32, ø40: Aluminum alloy	ø32, ø40: Clear anodized
9	Bumper	Urethane rubber	
10	Rubber magnet	Synthetic rubber	

Parts list

No.	Description	Material	Note
11	Steel balls	High carbon chromium bearing steel	
12	Needle roller	High carbon chromium bearing steel	
13	Parallel pin	Stainless steel	
14	C type snap ring	Carbon steel	Nickel plated
15	Exhaust plug A	Brass	Electroless nickel plated
16	Exhaust filter A	Polyvinyl formal	
18	N.C. spring	Stainless steel spring wire	
19	Rod seal	NBR	
20	Piston seal	NBR	
21	Gasket	NBR	

Additional information

Catalogue

[MHZ_EU.pdf](#)

Operation manuals

[OM_MHZ2_OMD0047EN-A.pdf](#)