

MXQ*Z, Air Slide Table, Height Interchangeable Type MXQ12-40Z

Datasheet

General series information

- Mounting: Interchangeable in mounting with the conventional model.
- Height: Same height as the conventional model.
- Lighter: Weight reduced up to 31%.
- Auto switch visibility improved.

Standard specifications

Bore Size	12 mm
Body Option	Standard
Stroke	40 mm
Adjuster Option	Z (Without Adjuster)
Functional Option	Without Functional Option
Auto Switch	No Switch
Lead Wire or Prewired Connector	0.5m (Or None in the Case of No Switch)
Number	2 pcs. (Or None in the Case of No Switch)
Made to Order	None
Side Adjuster Position	None (or Standard Type)
Pressure medium	Compressed air
Maximum temperature of pressure medium	60 °C
Minimum temperature of pressure medium	-10 °C
Maximum operating pressure	0.7 MPa
Minimum operating pressure	0.15 MPa
Proof pressure	1.05 MPa
Maximum ambient temperature	60 °C
Minimum ambient temperature	-10 °C
Number of pneumatic connections	2 pcs.

Pneumatic input connection	M5 x 0.8
Mode of operation of drive	Double acting
Theoretical cylinder force, advance stroke (at 0.5 MPa)	113 N
Theoretical cylinder force, return stroke (at 0.5 MPa)	85 N
Maximum piston speed	500 mm/s
Type of cushioning	Internal rubber bumper
Weight	0.400 Kg

Dimensions

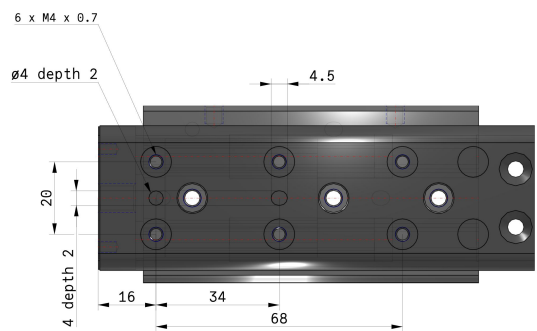
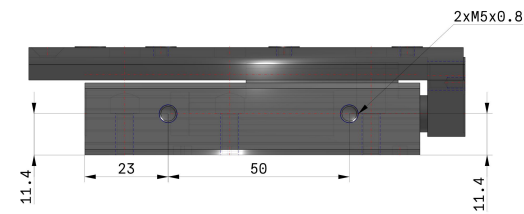
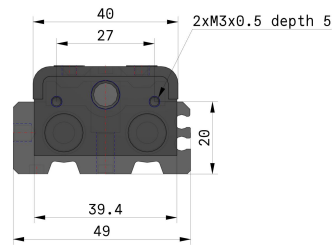
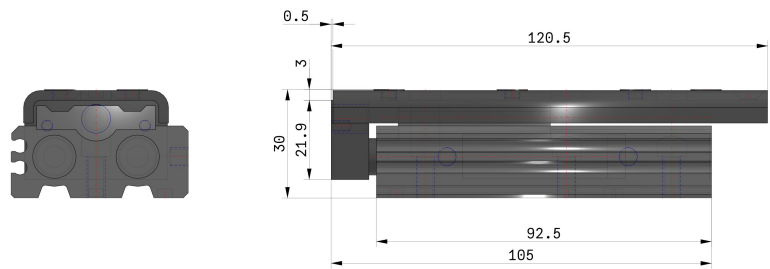
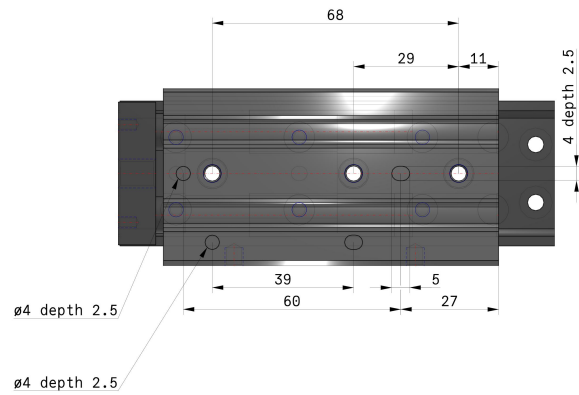

Specifications are subject to change without prior notice and any obligation on the part of the manufacturer.

Additional information

Catalogue

[MXQ-Z-C_EU.pdf](#)

Operation manuals

[OM_MXQ-Z_OMP0038EN-D.pdf](#)