

IR1000~3000, Precision Regulator IR1000-01

- Precision regulator
- Regulating pressure range (MPa): 0.005 to 0.8 depending on model
- Compact and lightweight
- Bracket & pressure gauge can be mouted on either the front or back
- 2 air operated models

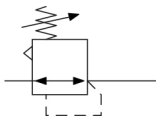

Pressure control valve, relieving pressure regulator, adjustable

Body Size	1 (IR1000)
Type of Setting	0 (Basic [Handle])
Set Pressure	0 (0.005~0.2MPa [IR1000/2000] or 0.01~0.2MPa [IR3000])
Thread	Rc(PT)
Port Size	01 (1/8 [IR1000 Only])
Accessory	None
Suffix 1	Standard
Suffix 2	None
Made to Order	None
Switch Specifications	None
-	Air
Maximum operating pressure	1.0 MPa
Minimum operating pressure	+0.05 Mpa
Sensitivity	Within 0.2% of full span
Repeatability	Within 0.5% of full span
Set pressure range	0.005 - 0.2 MPa
Linearity	Within 1% of full span
Air consumption (At supply pressure of 1.0 MPa)	4.4 l/min (ANR) or less
Input signal pressure	0.01 - 0.8 Mpa

Weight

0.101 Kg

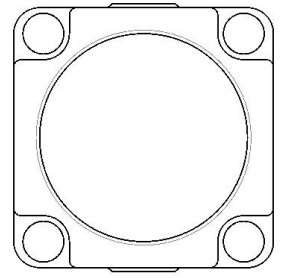
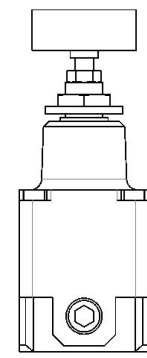
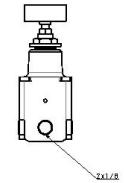
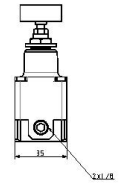
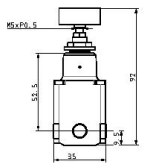
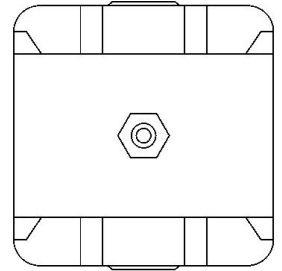

Construction

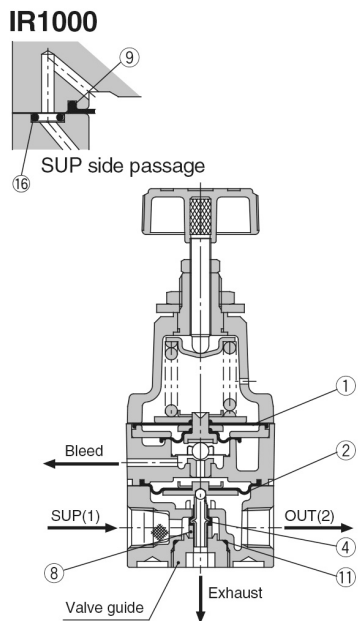

Replacement Parts

No.	Description	Material	IR10□0	
			Part no.	Qty.
1	Diaphragm assembly	NBR, other	P362010-1	1
2	Diaphragm assembly	NBR, other	P362010-2	1
3	Diaphragm	NBR, other	—	—
4	Valve	Stainless steel, NBR	P36201058	1
5	Valve	Stainless steel, NBR	—	—
6	Valve	Brass, NBR	—	—
7	Valve	Brass, NBR	—	—
8	Damper	NBR, other	P36201021	1
9	O-ring	H-NBR	ø2.5 x 1.05	3
10	O-ring	NBR	—	—
11	O-ring	NBR	ø10 x 1.3	1
12	O-ring	NBR	—	—
13	O-ring	NBR	—	—
14	Seal (A)	NBR	—	—
15	Seal (B)	NBR	—	—
16	Fixed throttle	Stainless steel	P36202018	1
Repair kit no. (A set of above nos. ① to ⑮.)			KT-IR1000	

-

-

[IR1000-2000-3000-B_EU.pdf](#)

-

[OM_IR30-OM00002EN-F.pdf](#)

[IR10-OM00006_GB.pdf](#)

[OM_IR20-OM00004EN-E.pdf](#)

[OM_IR20_OM00002EN-F.pdf](#)

[OM_IR10_OM00002EN-E.pdf](#)

[OM_IR30_OM00004EN-F.pdf](#)