

C(D)QM (ø40 to ø100), Compact Cylinder, Guide Rod Type CDQMB63TF-100

Datasheet

General series information

- Guide rod type compact cylinder
- Bore sizes (mm): 40, 50, 63, 80, 100
- Standard strokes (mm): 5 to 100
- 4 times the lateral load resistance of the CQ2K
- Non-rotating accuracy 0.2 or less



Double-acting cylinder with cushioning adjustable at both ends, single piston rod

Standard specifications

Magnet	D (Built-in)
Mounting	B [Through Hole (Standard)]
Bore Size	Ø63 mm
Port Thread	TF [G]
Stroke	100 mm
Auto Switch	No Switch
Lead Wire or Prewired Connector	0.5 m (Or None in the Case of No Switch)
Number	2 pcs. (Or None in the Case of No Switch)
Pressure medium	Compressed air
Maximum temperature of pressure medium with magnet	60 °C
Minimum temperature of pressure medium with magnet	-10 °C (with no freezing)
Maximum operating pressure	1.0 MPa
Minimum operating pressure	0.1 MPa
Proof pressure	1.5 MPa
Maximum ambient temperature with magnet	60 °C
Minimum ambient temperature with magnet	-10 °C (with no freezing)
Number of pneumatic connections	2 pcs.
Pneumatic input connection	G 3/8

Pneumatic exhaust connection	G 3/8
Theoretical cylinder force, advance stroke (at 0.5 MPa)	1.560
Theoretical cylinder force, return stroke (at 0.5 MPa)	1.400
Maximum piston speed	300 mm/s
Type of cushioning	Rubber bumper on both ends
Piston rod end	Without thread
Non-rotating accuracy of plate	$\pm 0.1^\circ$
Allowable rotational torque	1.61N·m
Weight	1.813 Kg

Dimensions

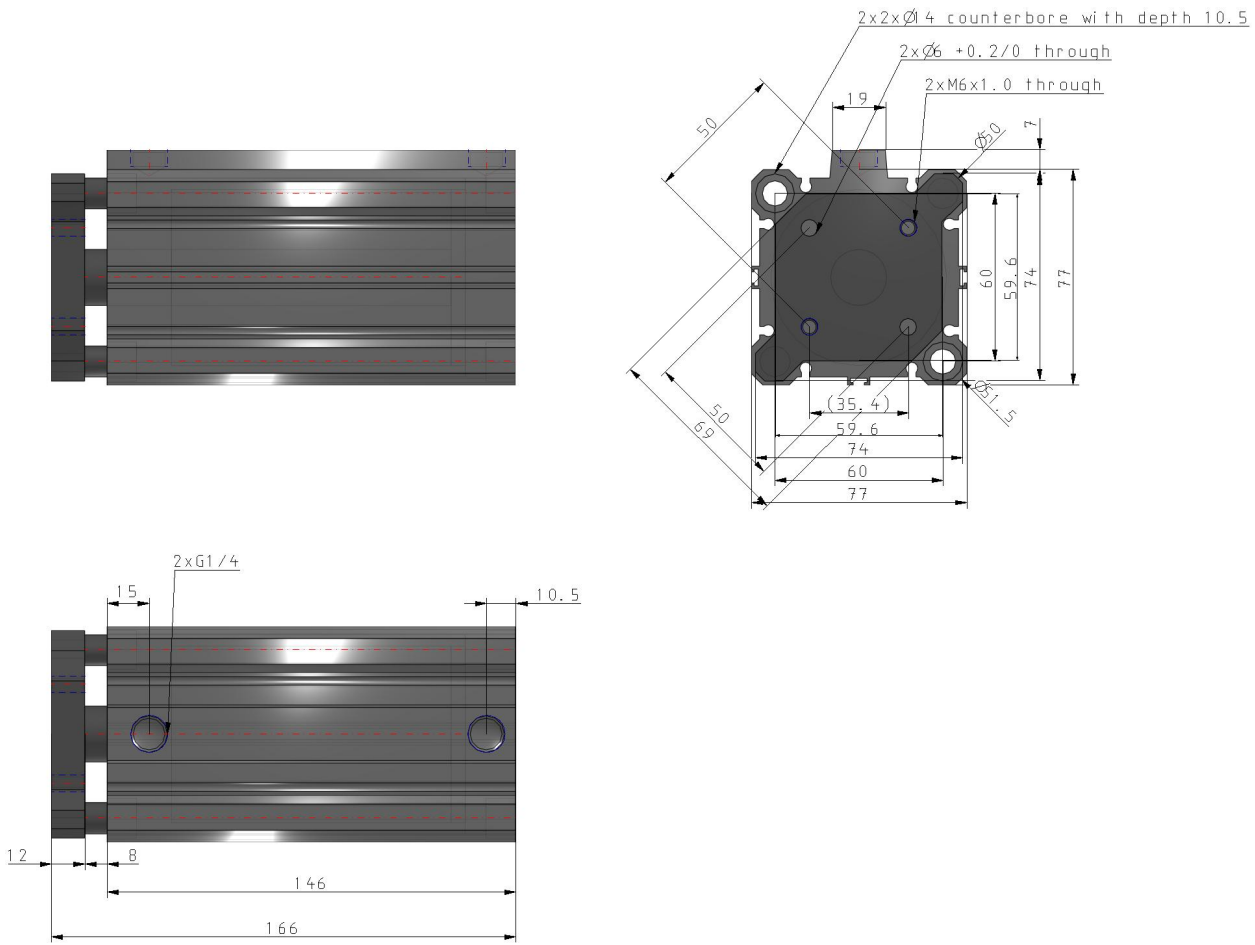

Constructions

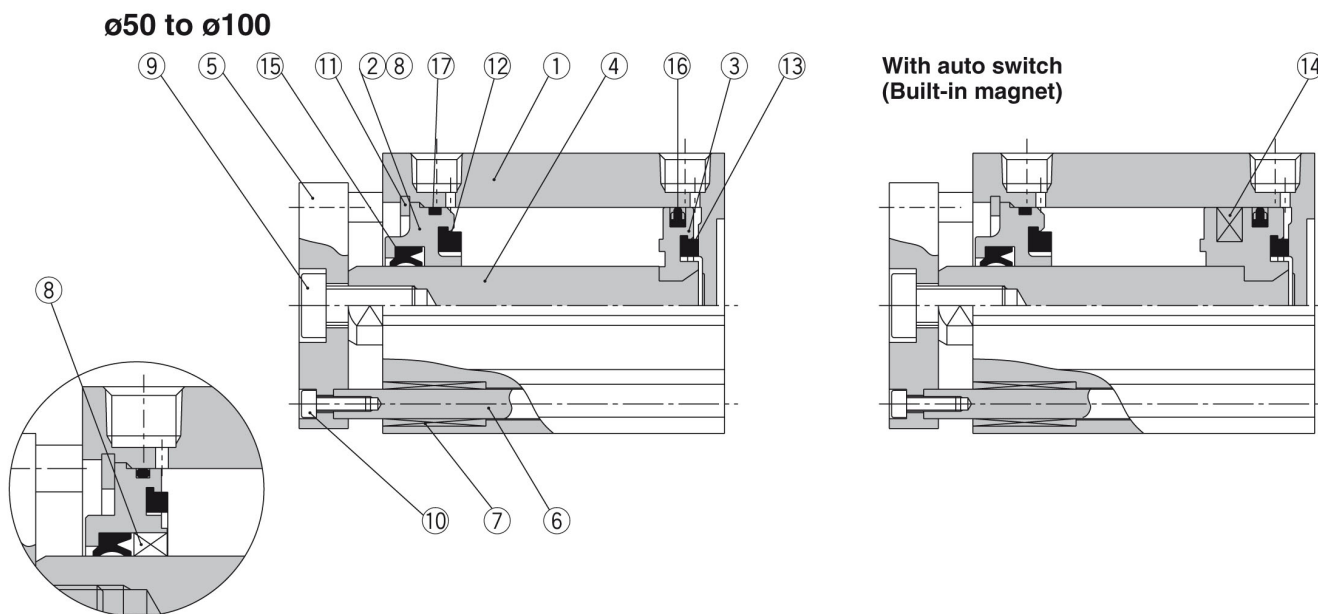

Component Parts

No.	Description	Material	Note
1	Cylinder tube	Aluminium alloy	Hard anodised
2	Collar	Aluminium alloy	Chromated, Coated
3	Piston	Aluminium alloy	Chromated
4	Piston rod	Carbon steel	Hard chrome plated
5	Plate	Aluminium alloy	Anodised
6	Guide rod	Stainless steel	Hard chrome plated
7	Bushing	Oil-impregnated sintered alloy	
8	Bushing	Bronze alloy	
9	Hexagon socket head cap screw	Carbon steel	Nickel plated
10	Hexagon socket head cap screw	Carbon steel	Nickel plated
11	Snap ring	Carbon tool steel	Phosphate coated
12	Bumper A	Urethan	
13	Bumper B	Urethan	
14	Magnet	—	
15	Rod seal	NBR	
16	Piston seal	NBR	
17	Gasket	NBR	

Additional information

Catalogue

[CQM_EU.pdf](#)

Operation manuals

[cqm_op_manual_cqm_-om0001c.pdf](#)