

C(D)QM, Compact Cylinder, Guide Rod Type CDQMB20-45

Datasheet

The CQM is a compact cylinder integrated with a guide rod and plate. The series is available in 12, 16, 20, 25, 32, 40, 50, 63, 80 and 100mm bore sizes with the same mounting dimensions as the CQ2. The guide rod and plate allow work to be directly mounted. The CQM series offers 4 times the lateral load resistance of the CQ2K and non-rotating accuracy of $\pm 0.2^\circ$.

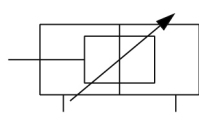

Double-acting cylinder with cushioning adjustable at both ends, single piston rod

Standard specifications

Magnet	D (Built-in)
Mounting	B [Through Hole (Standard)]
Bore Size	Ø20 mm
Port Thread	M Thread
Rc	
Stroke	45 mm
Auto Switch	No Switch
Lead Wire or Prewired Connector	0.5 m
Number	2 pcs.
Pressure medium	Compressed air
Maximum temperature of pressure medium with magnet	60 °C
Minimum temperature of pressure medium with magnet	-10 °C (with no freezing)
Maximum operating pressure	1.0 MPa
Minimum operating pressure	0.1 MPa
Proof pressure	1.5 MPa
Maximum ambient temperature with magnet	60 °C
Minimum ambient temperature with magnet	-10 °C (with no freezing)
Number of pneumatic connections	2 pcs.
Pneumatic input connection	M5
Pneumatic exhaust connection	M5

Theoretical cylinder force, advance stroke (at 0.5 MPa)	157
Theoretical cylinder force, return stroke (at 0.5 MPa)	118
Maximum piston speed	500 mm/s
Type of cushioning	Rubber bumper on both ends
Piston rod end	Without thread
Non-rotating accuracy of plate	$\pm 0.1^\circ$
Allowable rotational torque	0.17N·m
Weight	0.242 Kg

Dimensions

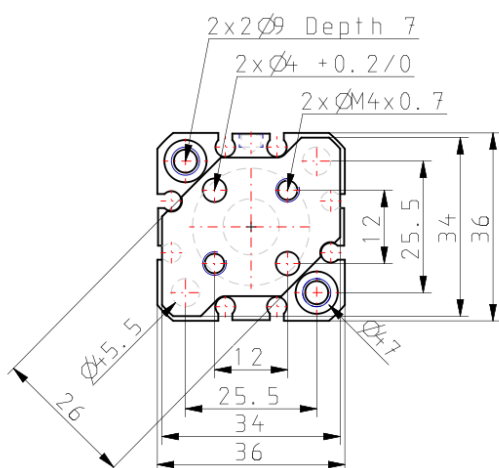
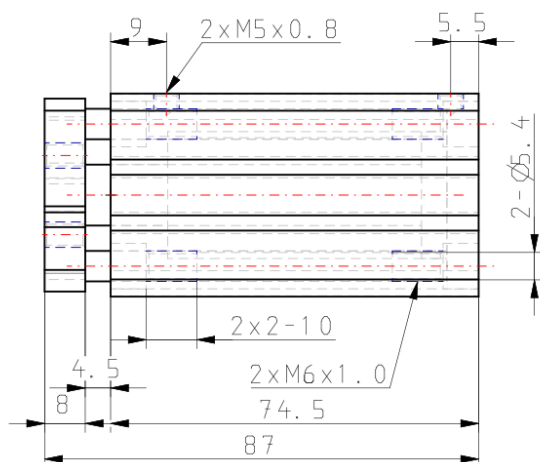

Constructions

ø12 to ø25

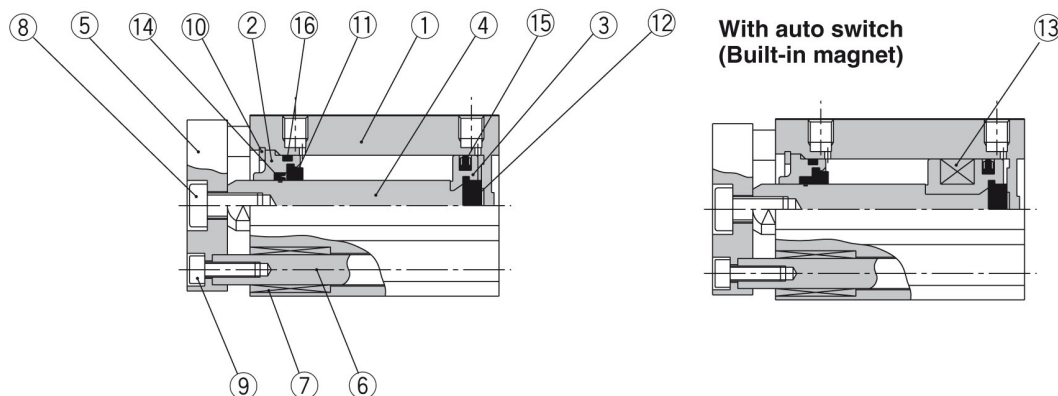

Component Parts

No.	Description	Material	Note
1	Cylinder tube	Aluminium alloy	Hard anodised
2	Collar	Aluminium alloy	Anodised
3	Piston	Aluminium alloy	Chromated
4	Piston rod	Stainless steel	
5	Plate	Aluminium alloy	Anodized
6	Guide rod	Stainless steel	Hard chrome plated
7	Bushing	Oil-impregnated sintered alloy	
8	Hexagon socket head cap screw	Carbon steel	Nickel plated
9	Hexagon socket head cap screw	Carbon steel	Nickel plated
10	Snap ring	Carbon tool steel	Phosphate coated
11	Bumper A	Urethan	
12	Bumper B	Urethan	
13	Magnet	—	
14	Rod seal	NBR	
15	Piston seal	NBR	
16	Gasket	NBR	

Additional information

Catalogue

[CQM_EU.pdf](#)