

In-line - AS*000 AS4000-02

Datasheet

General series information

- Port Size: M3, M5, 1/8, 1/4, 3/8, 1/2
- Operating Pressure Range: 0.05 to 1 MPa.



Flow control valve, adjustable, with reverse free flow

Standard specifications

Size	4 (1/2 Basis)
Thread	Rc (Metric Thread, M3, M5)
Port Size	02 (1/4)
Option	None
Lock Nut	Standard (Hexagon)
Pressure medium	Air
Maximum operating pressure	1 MPa
Minimum operating pressure	0.05 MPa
Proof pressure	1.5 MPa
Maximum ambient temperature	60 °C
Minimum ambient temperature	-5 °C
Weight	0.205 Kg

Dimensions

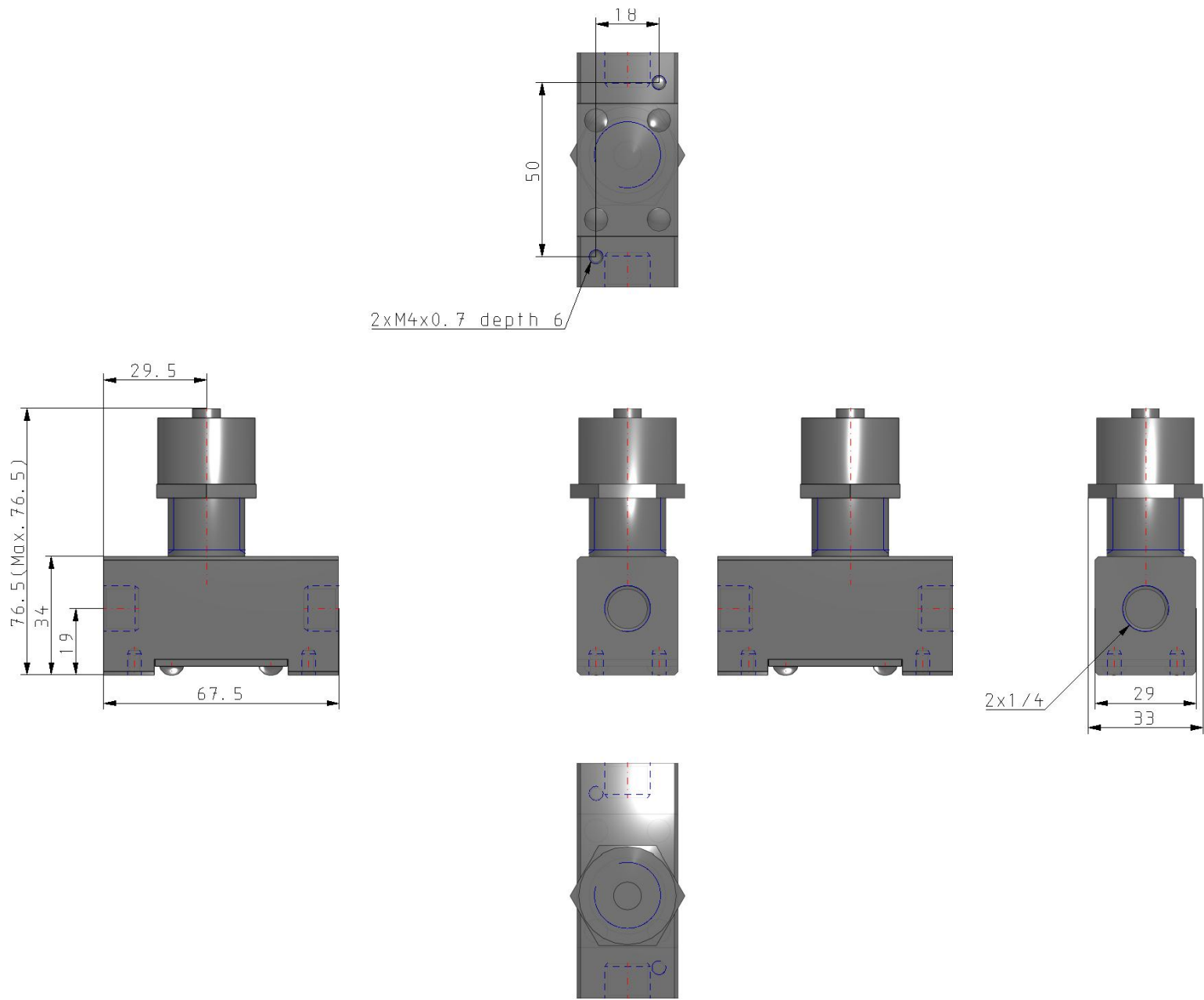

Specifications are subject to change without prior notice and any obligation on the part of the manufacturer.

Constructions

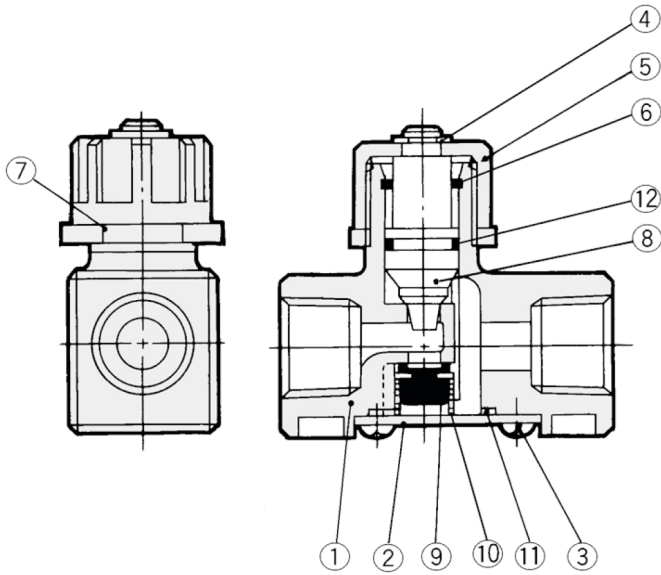

Component Parts

No.	Description	Material	Note
①	Body	Aluminum alloy	Chromated
②	Cap	Rolled steel	Zinc chromated
③	Head cap screw	Steel wire	4 X 0.7 X 8
④	E type snap ring	Stainless steel	JIS B2805 Nominal 6
⑤	Handle	Zinc	Chromated
⑥	Ring	Steel wire	Zinc chromated
⑦	Lock nut	Zinc alloy	
⑧	Needle	Aluminum alloy	
⑫	O ring	NBR	

No.	Description	Material
⑨	Valve	NBR, Brass
⑩	Spring	Stainless steel
⑪	O ring	NBR

Additional information

Catalogue

[AS_000-A_EU.pdf](#)

Operation manuals

[OM_ASx000_OMA0069EN-E.pdf](#)