

PF3W7, Digital Flow Switch for Water, 3-Colour Display, Integrated display

PF3W721-F14-FN-M

Datasheet

General series information

- Compact size.
- Rotary display.
- Display visibility improved.
- Built-in temperature sensor.
- IP65, RoHS Compliant & CE Compliant.

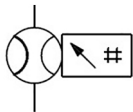

Flow meter with digital display

Standard specifications

Rated Flow Range	21 (50 to 250 l/min)
Flow Adjustment Valve	None
Thread Type	F (G)
Port Size	14 (1 1/2)
Output Specification	F (OUT1: PNP - OUT2: Analogue 4 to 20 mA)
Temperature Sensor	None
Lead Wire	N (Without Lead Wire, With M8 Connector)
Integrated display/Unit specification	M (Flow Rate: l/min, Temperature: °C)
Bracket	None
Calibration Certificate	None
Made to Order	None
Proof pressure	1.5 MPa
General power supply	12 to 24 VDC ±10 %
Response time	0.5 s/ 1 s/ 2 s
Intenal voltage drop	1.5 V or less (at load current of 80 mA)
Current consumption	50 mA or less
Material	PPS, Stainless steel 304, FKM, SCS13, Non-grease
Enclosure	IP65

Repeatability	±2 % F.S.
Applicable fluid	Water and ethylene glycol aqueous solution (with viscosity of 3 mPa·s [3 cP] or less)
Analog current output	4 to 20 mA Max. load impedance: 300 Ω for 12 VDC, 600 Ω for 24 VDC
Flow display range	20 to 350 l/min (Flow under 20 l/min is displayed as "0")
Operating temperature range	Operation, Storage: 35 to 85 % R.H. (No condensation)
Pressure range	0 - 1 MPa
Accuracy	Display value: ±3 % F.S. Analogue output: ±3 % F.S.
Smallest settable increment	2 l/min
Max. load current	80 mA
Hysteresis mode	Variable
Display	2-screen display (Main screen: 4-digit, 7-segment, 2-colour, Red/Green Sub screen: 6-digit, 11-segment, White) Display values updated 5 times per second
Indicator light	Output 1, Output 2: Orange
Withstand voltage	1000 VAC for 1 minute between terminals and housing
Insulation resistance	50 MΩ or more (500 VDC measured via megohmmeter) between terminals and housing
Temperature characteristics	±5 % F.S. (25 °C standard)
Standards	CE, UL
Flow detection method	Karman vortex
Switch output protection	Short-circuit protection
Fluid temperature	0 to 70 °C (No freezing or condensation)
Pressure loss (without flow adjustment valve)	60 kPa or less at the maximum flow
Conversion of accumulated pulse (Pulse width: 50 ms)	2 L/pulse
Display unit	Instantaneous flow: l/min, Accumulated flow: L
Accumulated flow range	999999999 L
Switch output mode Flow rate	Select from Hysteresis, Window comparator, Accumulated output, or accumulated pulse output modes.
Switch output mode Temperature	Select from Hysteresis mode or Window comparator mode.
Set flow range	20 - 350 l/min
Switch output Max. applied voltage	28 VDC
Weight	0.890 Kg

Dimensions

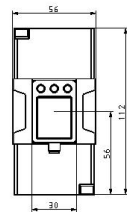
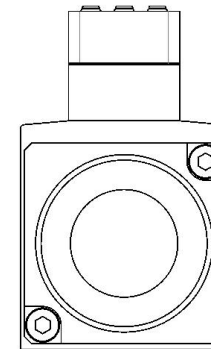
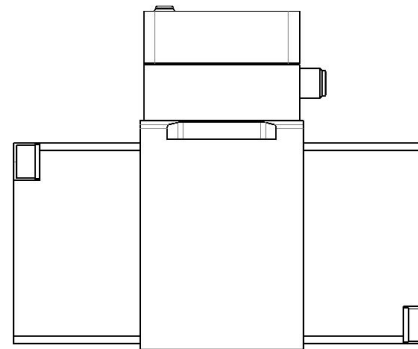
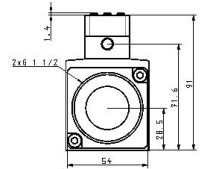
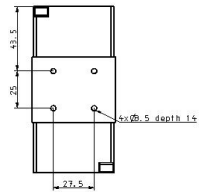
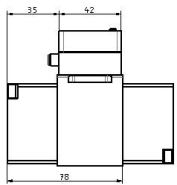

Constructions

*This construction image does not include the display

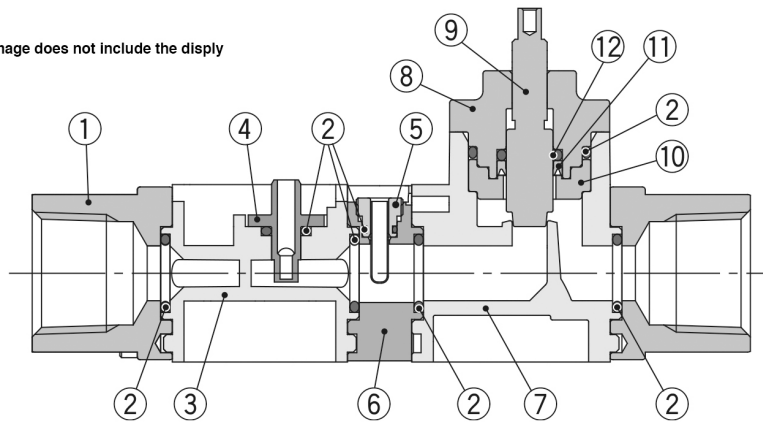

Component Parts

No.	Description	Material	Note
1	Attachment	SCS13	Stainless steel 304 equivalent PF3W704/720/740/711/504/520/540/511
		Stainless steel 304	PF3W721/521
2	Seal	FKM	
3	Body	PPS	
4	Sensor	PPS	
5	Temperature sensor	Stainless steel 304	
6	Temperature sensor body	Stainless steel 304	
7	Flow adjustment valve body	PPS	
8	Flow adjustment valve cover	PPS	
9	Flow adjustment valve shaft	Stainless steel 304	
10	Shaft support	PPS	
11	Seal	FKM	
12	Seal	FKM	

Additional information

Catalogue	PF3W-Dd_EU.pdf
Declaration of conformity	newDoC_PF3W_TF1Y123EN.pdf DoC_PF3Wx_TFG0006.pdf
Installation manuals	IM_PF3W7_TF2Z076EN-B.pdf
Operation manuals	OM_PF3W7_OMM0005EN-Q.pdf