

IS10, Pressure Switch, Reed Switch Type

IS10-01S-6L

Datasheet

General series information

- Weight: 62g (16% lighter than IS1000)
- Overall height: 52mm (11% smaller than IS1000)
- 100V AC/DC specifications
- Service life: 5 million cycles
- Can be connected to modular type FRL units
- RoHS compliant & CE marked

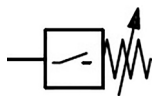

Adjustable pressure switch

Standard specifications

Thread	R
Seal	S (Seal)
Options	6L (6 + L)
Maximum operating pressure	0.7 MPa
Proof pressure	1.0 MPa
Approvals	CE
Enclosure	IP40
Repeatability	±0.05 MPa
Port size	1/8
Applicable fluid	Air/Inert gas
Operating temperature range	-5 - 60°C
Hysteresis	Fixed 0.08 MPa or less
Contacts	1a
Error of scale	±0.05 MPa
Weight	0.062 Kg

Dimensions

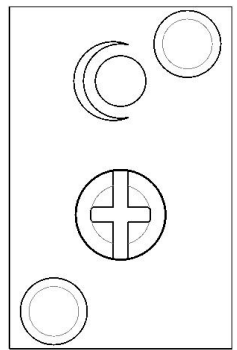
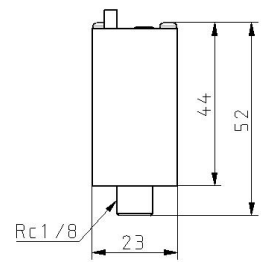
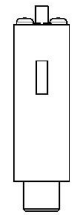
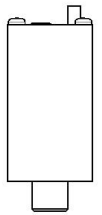
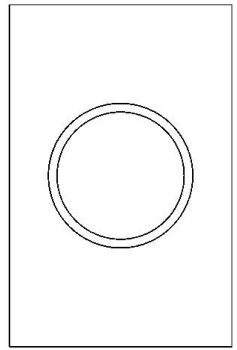

Constructions

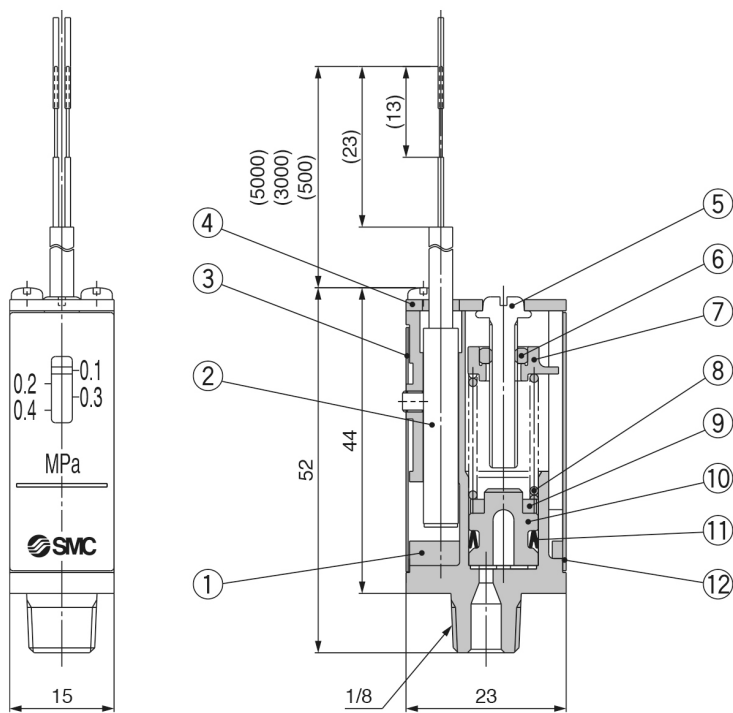

Component Parts

No.	Description	Material
1	Body	ZDC
2	Switch assembly	—
3	Shield plate	Steel sheet
4	Cover	Steel sheet
5	Adjusting screw	Brass
6	Hexagon nut	Brass
7	Indicator	PBT
8	Spring	Stainless steel
9	Magnet	—
10	Piston	POM
11	Seal piston	NBR
12	Scale plate	PC

Additional information

Catalogue	IS10-A_EU.pdf
Declaration of conformity	newDoC_IS10_TF122122EN.pdf newDoC_IS10_TF1V346EN.pdf
Installation manuals	IM_IS10_SMW02EN.pdf
Operation manuals	OM_IS10_IS-OMO0044EN.pdf