

C(D)RA1-Z*30-100, Rotary Actuator, Rack & Pinion, Standard CRA1BS50TF-180CZ

Datasheet

General series information

- Rotary actuator
- Sizes: 30, 50, 63, 80, 100
- Rotating angle: 90°, 100°, 180°, 190°
- Adjustable rotation time range: from 0.2 to 5 s/90°.

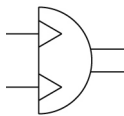

Semi-rotary actuator, double acting

Standard specifications

Magnet	None
Mounting	B (Basic)
Shaft Type	S (Single Shaft)
Angle Adjusting Unit	None
Type	Pneumatic
Size	50 mm
Port Thread	TF (G)
Rotation Angle	180°
Type of Cushioning	C (Air Cushion)
Auto Switch	No Switch
Lead Wire or Prewired Connector	0.5m (Or None in the Case of No Switch)
Number	2 pcs.
Pressure medium	Compressed air (non-lube)
Maximum temperature of pressure medium	60 °C
Minimum temperature of pressure medium	0 °C
Maximum operating pressure	1.0 MPa
Minimum operating pressure	0.1 MPa
Maximum ambient temperature	60 °C
Minimum ambient temperature	0 °C

Number of pneumatic connections	2 pcs.
Pneumatic pilot connections	G 1/8
Mode of operation of drive	Double acting
Weight	1.500 Kg

Dimensions

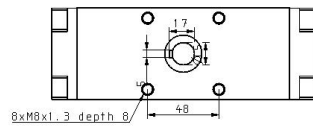
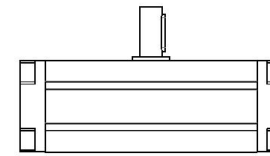
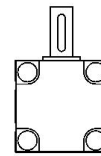
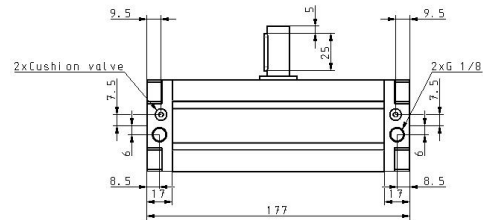
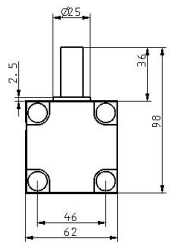
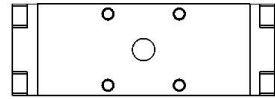

Constructions

Construction: Size 50 to 100

Without air cushion

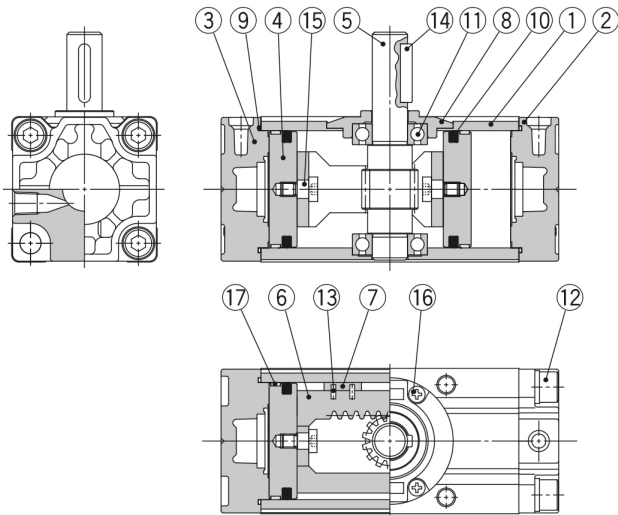

With air cushion

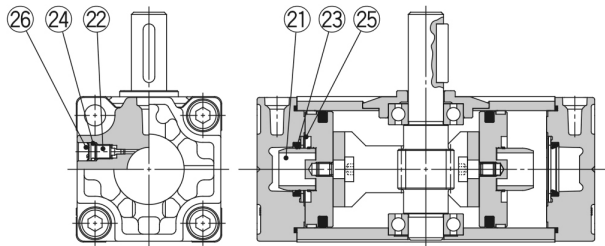

Without air cushion With auto switch

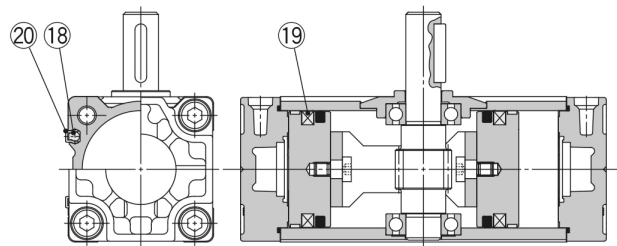

Component Parts

No.	Description	Material	Note
1	Body	Aluminium alloy	Anodised
2	Right cover	Aluminium alloy	Metallic coating
3	Left cover	Aluminium alloy	Metallic coating
4	Piston	Aluminium alloy	
5	Shaft	Alloy steel	
6	Rack	Carbon steel	Nitrided
7	Slider	Resin	
8	Bearing retainer	Aluminium alloy	Chromated
9	Tube gasket	NBR	
10	Piston seal	NBR	
11	Bearing	High carbon chrome bearing steel	
12	Hexagon socket head cap screw with washer	Alloy steel	Zinc chromated
13	Spring pin	Steel	Zinc chromated
14	Parallel key	Carbon steel	
15	Connecting screw	Carbon steel	Zinc chromated
16	Cross-recessed pan head tapping screw	Steel	Zinc chromated
17	Wear ring	Resin	
18	Auto switch	—	
19	Magnet	—	
20	Switch spacer	Resin	
21	Cushion ring	Aluminium alloy	Anodised
22	Cushion valve	Steel	Zinc chromated
23	Cushion seal	Urethane	
24	O-ring	NBR	
25	Seal retainer	Steel	
26	Retaining ring	Steel	

Additional information

Catalogue

[CRA1-C-Z_EU.pdf](#)

Operation manuals

[OM_CRA1-Z_OM00006EN-E.pdf](#)