

Standard - MHF2 MHF2-20D

Datasheet

General series information

- Maximum gripping force per finger 141 N at 0.5 MPa
- Double acting
- Repeatability: ± 0.05 mm
- Max. operating frequency: 120 c.p.m.



Gripper, external grip, double-acting with permanent magnet on piston

Standard specifications

Bore Size	20mm
Opening & Closing Stroke	Short Stroke
Body Option	Axial Direction Ported
Auto Switch	No Switch
Lead Wire or Prewired Connector	0.5m (Or None in the Case of No Switch)
Number	2 pcs (Or None in the Case of No Switch)
Option	None
Stroke Adjustable Side	None
Stroke Adjustable Width	None
Pressure medium	Air
Maximum temperature of pressure medium	60 °C
Minimum temperature of pressure medium	-10 °C (No freezing)
Maximum operating pressure	0.7 MPa
Minimum operating pressure	0.1 MPa
Maximum ambient temperature	60 °C
Minimum ambient temperature	-10 °C (No freezing)
Number of pneumatic connections	2 pcs.
Pneumatic input connection	M5
Pneumatic exhaust connection	M5

Repeatability	± 0.05 mm
Lubrication	Non-lube
Type of gripper	Parallel
Number of fingers	2
Mode of operation	Double acting
Maximum operating frequency	120 c.p.m.
Effective holding force per finger (0.5 MPa)	141 N
Opening / closing stroke (both sides)	20 mm
Weight	0.666 Kg

Dimensions

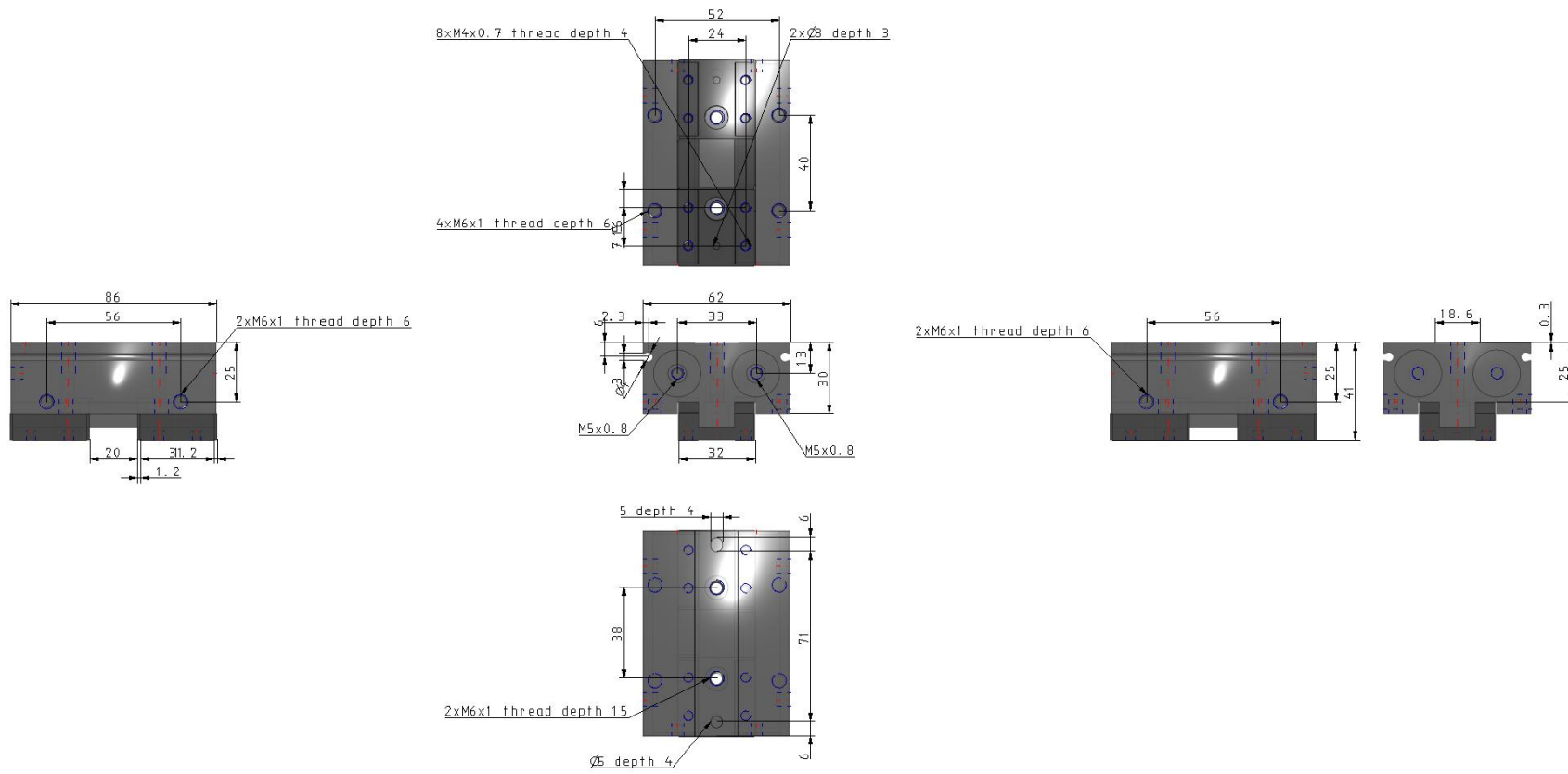

Constructions

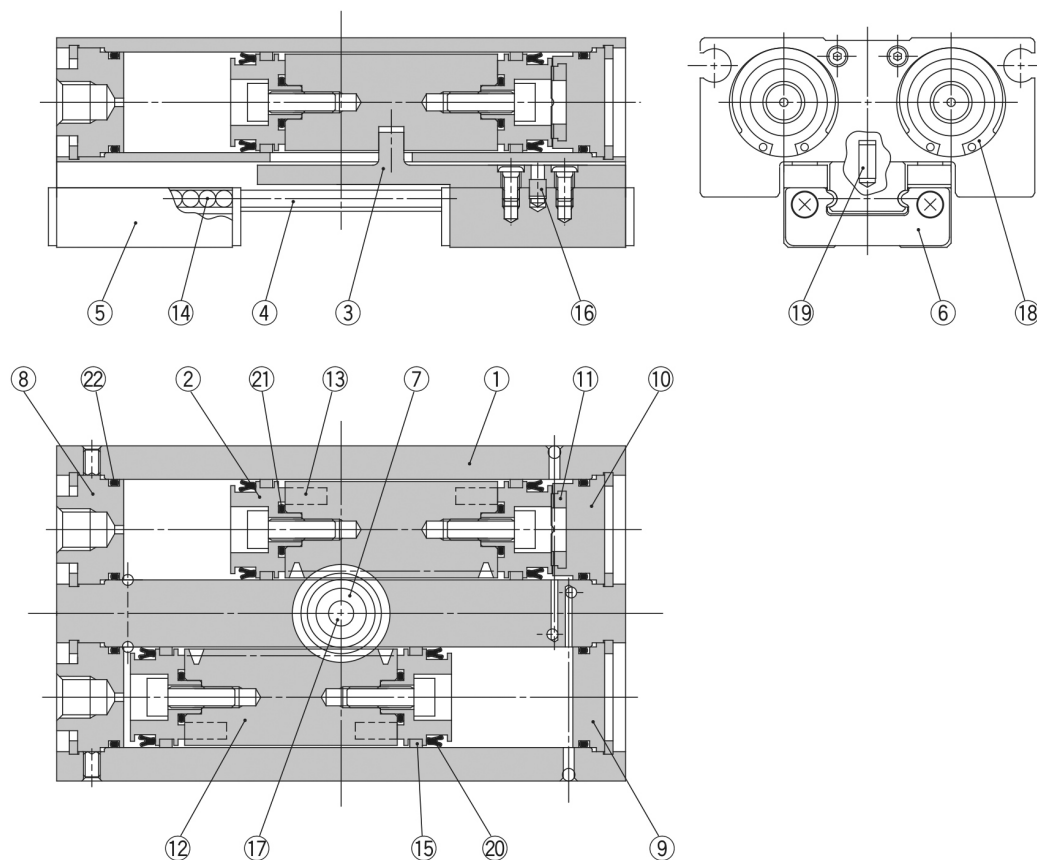

Parts list

No.	Description	Material	Note
1	Body	Aluminium alloy	Hard anodized
2	Piston	Aluminium alloy	Clear anodized
3	Joint	Stainless steel	Heat treatment
4	Guide rail	Stainless steel	Heat treatment
5	Finger	Stainless steel	Heat treatment
6	Roller stopper	Stainless steel	
7	Pinion	Carbon steel	Nit riding
8	Cap A	Aluminium alloy	Clear anodized
9	Cap B	Aluminium alloy	Clear anodized
10	Cap C	Aluminium alloy	Clear anodized
11	Head damper	Urethane rubber	
12	Rack	Stainless steel	Nit riding

Parts list

No.	Description	Material	Note
13	Magnet	Tare earth magnet	Nickel plated
14	Steel balls	High carbon chromium bearing steel	
15	Wear ring	Synthetic resin	
16	ø12: Roller	High carbon chromium bearing steel	
	ø16 to 20: Parallel pin	Stainless steel	
17	Needle roller	High carbon chromium bearing steel	
18	ø12: R shape snap ring	Carbon steel	Nickel plated
	ø16 to 20: C type snap ring		
19	Parallel pin	Stainless steel	
20	Piston seal	NBR	
21	Gasket	NBR	
22	Gasket	NBR	

Additional information

Catalogue

[MHF2-B_EU.pdf](#)

Operation manuals

[OM_MHF2_OMF0021EN-A.pdf](#)