

## MSQ\*10~200, Rotary Table, Rack & Pinion, Basic & High Precision MSQB10R

Datasheet

### General series information

- Rack & Pinion style, rotary table-basic type
- Seven bore sizes available
- Direct load mounting possible
- Adjustment from one direction
- Auto switch capable

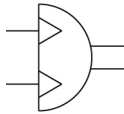

*Semi-rotary actuator, double acting*

### Standard specifications

Clean Series	None
Model	MSQ
Precision	B (Basic)
Size	10
Suffix	R (Shock Absorbers)
Auto Switch	No Switch
Lead Wire or Prewired Connector	0.5m [Or None in the Case of No Switch]
Number	2 pcs. [Or None in the Case of No Switch]
Thread Type	M5 [10,20]; Rc 1/8 [30,50,70,100,200]
Pressure medium	Compressed air (non-lube)
Maximum temperature of pressure medium	60 °C
Minimum temperature of pressure medium	0 °C
Maximum operating pressure	0.6 MPa
Minimum operating pressure	0.1 MPa
Maximum ambient temperature	60 °C
Minimum ambient temperature	0 °C
Number of pneumatic connections	4 pcs.
Pneumatic input connection	M5

Mode of operation of drive	Double acting
Type of cushioning	Shock absorber
-	0° to 190°
Weight	0.510 Kg

Specifications are subject to change without prior notice and any obligation on the part of the manufacturer.

# Dimensions

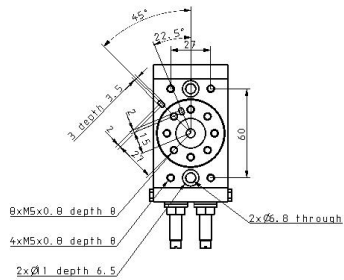
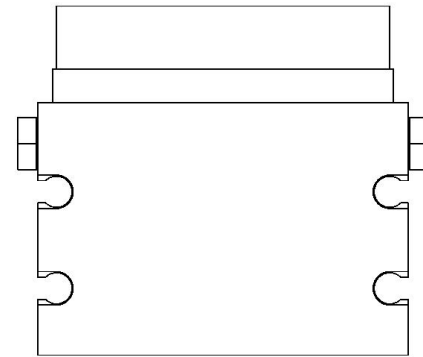
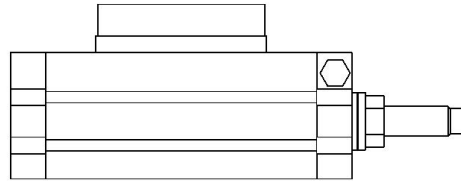
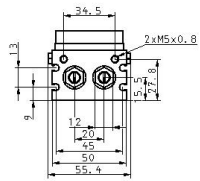
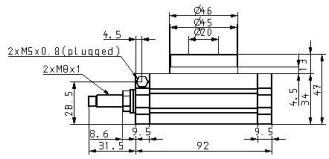
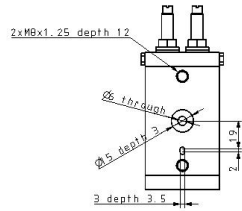

Specifications are subject to change without prior notice and any obligation on the part of the manufacturer.

## Constructions

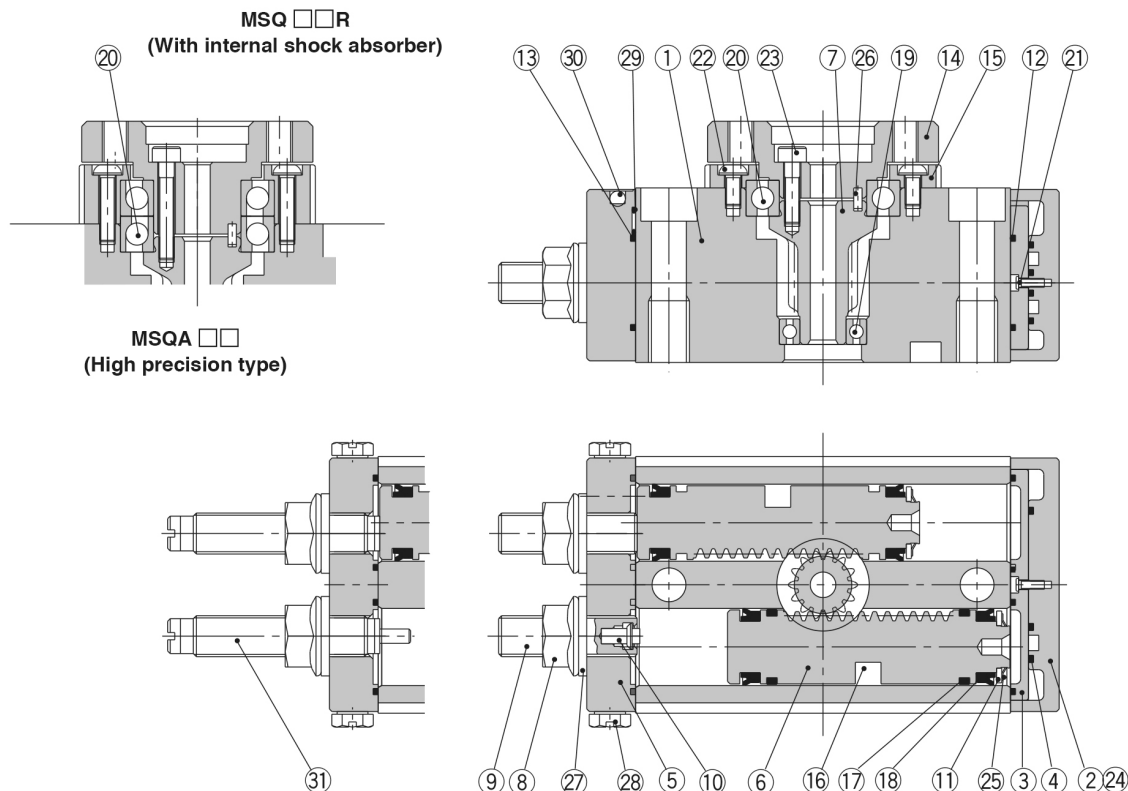

### Parts list

No.	Description	Material
1	Body	Aluminium alloy
2	Cover	Aluminium alloy
3	Plate	Aluminium alloy
4	Seal	NBR
5	End cover	Aluminium alloy
6	Piston	Stainless steel
7	Pinion	Chrome molybdenum steel
8	Hexagon nut with flange	Steel wire
	Hexagon nut	
9	Adjustment bolt	Chrome molybdenum steel
10	Cushion pad	Rubber material
11	Seal retainer	Aluminium alloy
12	Gasket	NBR
13	Gasket	NBR
14	Table	Aluminium alloy
15	Bearing retainer	Aluminium alloy
16	Magnet	Magnetic material
17	Wear ring	Resin
18	Piston seal	NBR

No.	Description	Material
19	Deep groove ball bearing	Bearing steel
	Needle bearing	
20	Deep groove ball bearing	Bearing steel
	Angular contact ball bearing	
21	Round head philips screw No.0	Steel wire
	Round head philips screw	
22	Low head cap screw	Chrome molybdenum steel
	Hexagon socket head set bolt	
	Hexagon socket head set bolt	
23	Hexagon socket head set bolt	Stainless steel
	Hexagon socket head set bolt	
24	Hexagon socket head set bolt	Carbon steel
	Hexagon socket head set bolt	
25	CS type snap ring	Spring steel
26	Parallel pin	Carbon steel
	Parallel key	
27	Seal washer	NBR
28	Plug	Brass
29	O-ring	NBR
30	Steel balls	Stainless steel
31	Shock absorber	—

### Replacement parts

Description	Kit no.							Note
	10	20	30	50	70	100	200	
Seal kit	KT-MSQ10	KT-MSQ20	KT-MSQ30	KT-MSQ50	KT-MSQ70	KT-MSQ100	KT-MSQ200	A set of above numbers (4), (12), (13), (17), (18) and (27)

## Additional information

Catalogue

[MSQ\\_EU.pdf](#)