

## MK-Z Rotary Clamp Cylinder, Standard w/Auto Switch Mounting Grooves

### MKB32-10LZ

Datasheet

### General series information

- Length has been reduced in comparison to MK2 and is similar in length to MK.
- Bore sizes (mm): 12, 16, 20, 25, 32, 40, 50, 63
- Compact auto switch D-M9 can be mounted on 4 sides.
- Magnetic field resistant auto switch can be used.
- 2 types of cylinder mounting are available with one body.



Double-acting, single-rod cylinder

### Standard specifications

Mounting	B (Through-hole/Both Ends Tapped Common, Basic)
Bore Size	Ø32 mm
Port Thread	M thread: ø12 to ø25, Rc: 32 to 63
Clamp Stroke	10 mm
Rotary Direction	L (Counterclockwise)
Body Option	Standard (Female Thread)
Auto Switch	No Switch
Lead Wire or Prewired Connector	0.5m [Or None in the Case of No Switch]
Number	2 pcs. [Or None in the Case of No Switch]
Made to Order	None
Pressure medium	Air
Maximum temperature of pressure medium	70 °C
Maximum temperature of pressure medium with magnet	60 °C
Minimum temperature of pressure medium	-10 °C (No freezing)
Minimum temperature of pressure medium with magnet	-10 °C (No freezing)
Maximum operating pressure	1.0 MPa
Minimum operating pressure	0.1 MPa
Proof pressure	1.5 MPa

Maximum ambient temperature	70 °C
Maximum ambient temperature with magnet	60 °C
Minimum ambient temperature	-10 °C (No freezing)
Minimum ambient temperature with magnet	-10 °C (No freezing)
Number of pneumatic connections	2 pcs.
Pneumatic input connection	R 1/8
Pneumatic exhaust connection	R 1/8
Mode of operation of drive	Double acting
Theoretical cylinder force, advance stroke (at 0.5 MPa)	402 N
Theoretical cylinder force, return stroke (at 0.5 MPa)	302 N
Maximum piston speed	200 mm/s
Type of cushioning	Rubber bumper
Piston rod end	Female thread
Female thread of rod end	M10
Weight	0.445 Kg

# Dimensions

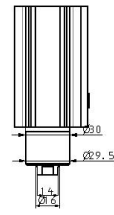
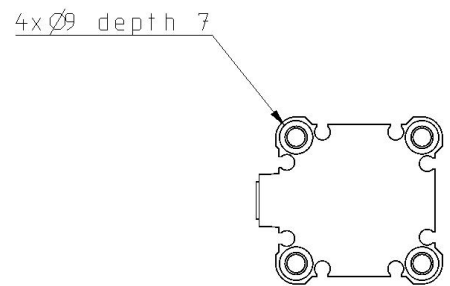
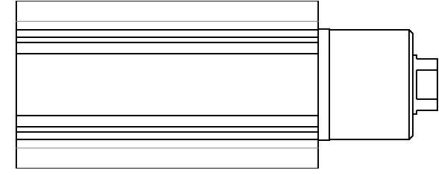
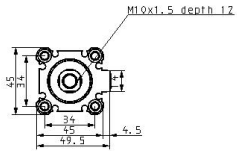
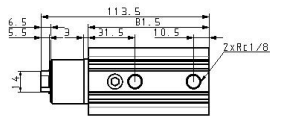
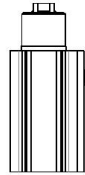

Specifications are subject to change without prior notice and any obligation on the part of the manufacturer.

## Constructions

### New MK20 to 32

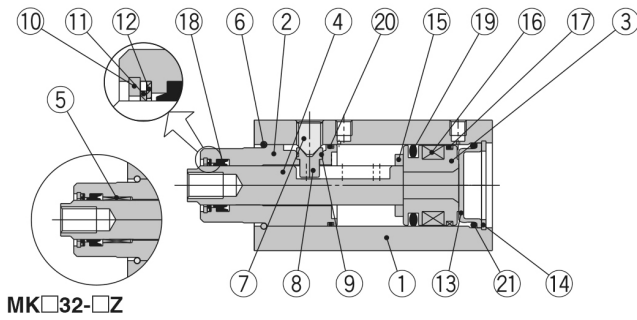

MK□32-□Z

### With arm (N)

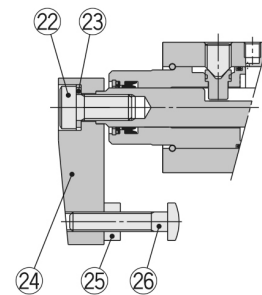

### Head flange (G)

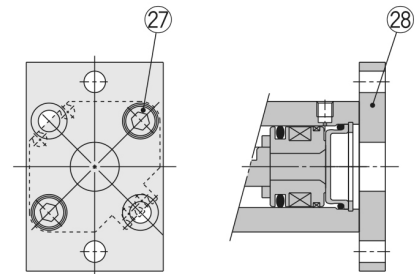

### Component Parts

No.	Description	Material	Note
1	Cylinder tube	Aluminum alloy	Hard anodised
2	Rod cover	Aluminum alloy	Hard anodised
3	Piston	Aluminum alloy	Chromated
4	Piston rod	Stainless steel	ø20 to ø25 Nitriding
		Carbon steel	ø32 Heated, Nickel plated
5	Bushing	Copper bearing material	ø32 only
6	Stop ring	Stainless steel	
7	Hexagon socket head set screw	Chromium molybdenum steel	Sharp end section: 90°
8	Guide pin	Stainless steel	Nitriding
9	O-ring	NBR	
10	Round R-type retaining ring	Carbon tool steel	
11	Coil scraper	Phosphor bronze	
12	Scraper pressure	Stainless steel	
13	Head cover	Rolled steel	Electroless nickel plated
14	C-type retaining ring	Carbon tool steel	
15	Bumper	Urethane	
16	Magnet	—	
17	Wear ring	Resin	
18	Rod seal	NBR	
19	Piston seal	NBR	
20	Gasket	NBR	
21	O-ring	NBR	
22	Hexagon socket head cap screw	Chromium molybdenum steel	
23	Spring washer	Hard steel	
24	Arm	Rolled steel	
25	Hexagon nut	Rolled steel	
26	Clamp bolt	Chromium molybdenum steel	
27	Hexagon socket head cap screw	Chromium molybdenum steel	Qty.
			ø20, ø25: 2 pcs. ø32: 4 pcs.
28	Flange	Rolled steel	

## Additional information

Catalogue

[MK-A\\_EU.pdf](#)