

## VHK-A, Finger Valve, One-touch Fitting

### VHK2A-08F-08F

Datasheet

### General series information

- 1(P)/2(A) One-touch fitting.

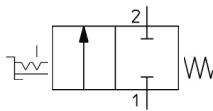

*Directional control valve 2/2-way valve, closed normal position return with control mechanism by turning return with mechanical control spring*

### Standard specifications

Valve	2 (2-Port Valve)
1(P) Applicable Tubing O.D.	ø 8
2(A) Applicable Tubing O.D.	ø 8
Knob Colour	Grey (2-port); Blue (3-port)
Bracket	None
Pressure medium	Air
Maximum temperature of pressure medium	60 °C
Minimum temperature of pressure medium	0 °C
Maximum operating pressure	1.0 MPa
Minimum operating pressure	-100 kPa
Proof pressure	1.5 MPa
Maximum ambient temperature	60 °C
Minimum ambient temperature	0 °C
Usable tubing material	Nylon, Soft nylon, Polyurethane
Weight	0.017 Kg

# Dimensions

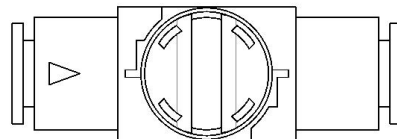
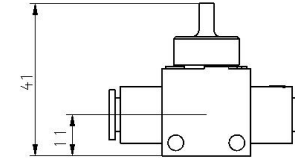
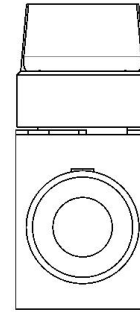
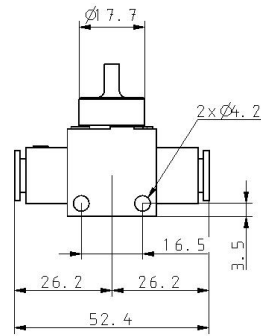
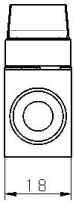

## Constructions

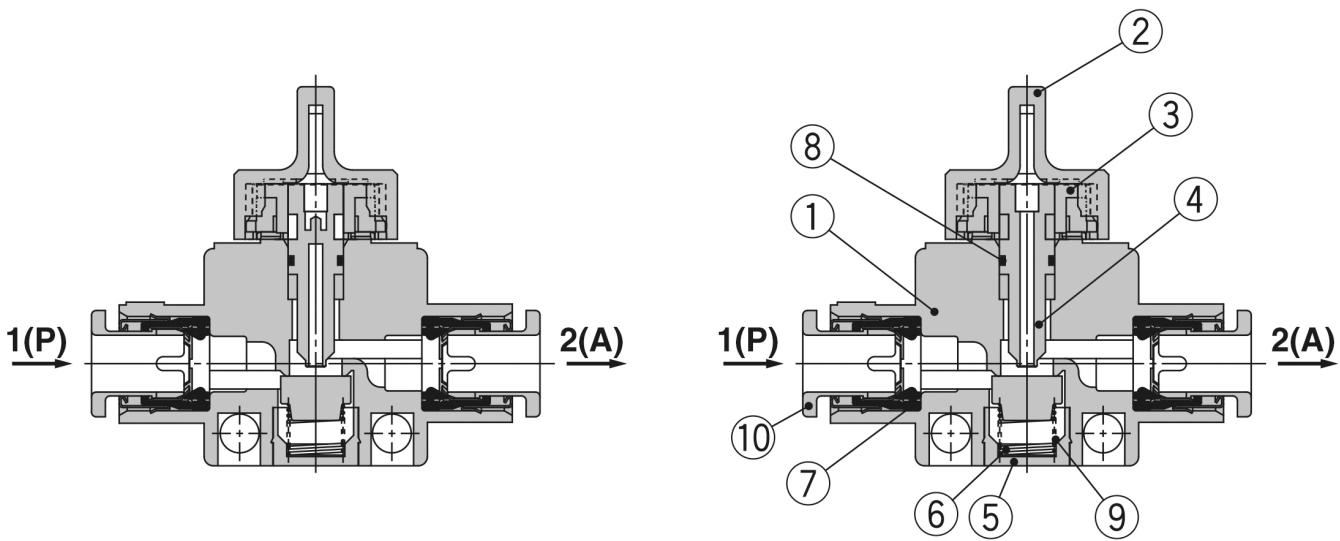

No.	Description	Material	Note
1	<b>Body</b>	PBT	
2	<b>Knob</b>	POM	
3	<b>Cam ring</b>	POM	
4	<b>Stem</b>	POM	
5	<b>Spring guide</b>	Brass	Electroless nickel plated
6	<b>Spring</b>	Stainless steel	
7	<b>Seal</b>	NBR	
8	<b>O-ring</b>	NBR	
9	<b>Valve</b>	NBR	
10	<b>Cassette</b>	—	

## Additional information

Catalogue

[VHK-Aa\\_EU.pdf](#)