

## Elbow - AS\*2\*1FS AS3201FS-03-08S

### Datasheet

### General series information

- Port Size: M5, 10-32 UNF, 1/8, 1/4, 3/8, 1/2
- Applicable Tubing O.D.: Ø 2 to Ø 16 mm and Ø 1/8" to Ø 1/2"
- Operating Pressure Range: 0.1 to 1 MPa.



Flow control valve, adjustable, with reverse free flow

### Standard specifications

Clean Series	None
Body Size	3 (3/8)
Type	2 (Elbow)
Control Type	0 (Meter-out)
Indicator Direction	0°
Thread	R (or None)
Port Size	03 (3/8)
Width Across Flats	9 mm (or None: Sizes 2/3/4)
Tubing	08 (ø8)
Seal	S (w/Sealant)
Made to Order	None
Pressure medium	Air
Maximum operating pressure	1 MPa
Minimum operating pressure	0.1 MPa
Proof pressure	1.5 MPa
Maximum ambient temperature	60 °C
Minimum ambient temperature	-5 °C
Applicable tubing material	Nylon, Soft nylon, Polyurethane
Weight	0.038 Kg

# Dimensions

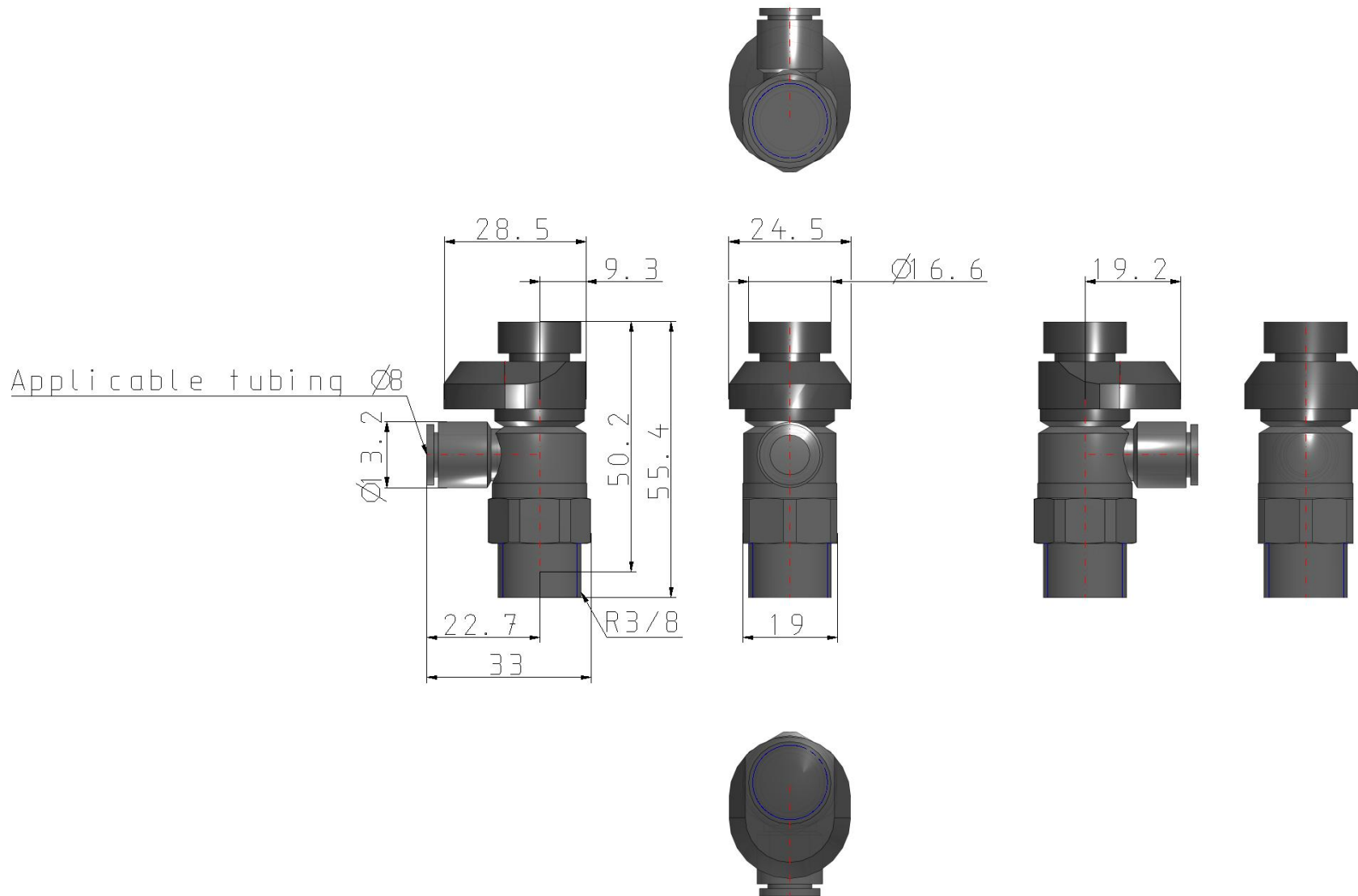

## Constructions

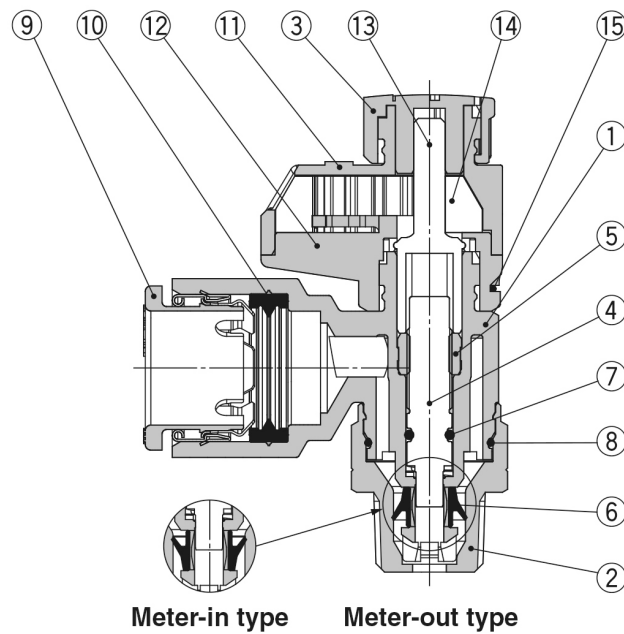

### Component Parts

No.	Description	Material	Note
1	Body A	PBT	
2	Body B	Brass	Electroless nickel plating
3	Knob	POM	
4	Needle	PBT	
5	Needle guide	Brass	Electroless nickel plating
6	U-seal	HNBR	
7	O-ring	NBR	
8	O-ring	NBR	
9	Cassette	—	
10	Seal	NBR	
11	Bonnet A	POM	
12	Bonnet B	POM	
13	Gear	POM	
14	Indicator gear	POM	
15	Clip	Stainless steel	

## Additional information

Catalogue

[AS-FS-D\\_EU.pdf](#)