

VBA2#A,4#A, Booster Regulator VBA43A-F04GS

Datasheet

General series information

- Service life increased.
- Noise reduced.
- Condensation reduced.
- Reliability improved.

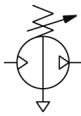

Pneumatic booster regulator, handle operated

Standard specifications

Made to Order	Standard
Body Size	43A (1/2, Max. operating pressure 1.6 MPa)
Thread Type	F (G [PF])
Port Size	04 (1/2)
Option	GS (Pressure Gauge [2 pcs.], High noise reduction silencer)
Semi-standard	Standard
Pressure medium	Compressed Air
Maximum operating pressure	1.0 MPa
Minimum operating pressure	0.2 MPa
Proof pressure	2.4 MPa
Maximum ambient temperature	50 °C
Minimum ambient temperature	2 °C (No freezing)
Approvals	No need
Number of pneumatic connections	3 pcs.
Flow rate	1600 l/min
Set pressure range	0.2 to 1.6 MPa
Port size	Rc 1/2
Pressure increase ratio	Twice

Pressure adjustment mechanism	Handle-operated with relief mechanism
Supply pressure range (MPa)	0.1 to 1.0 MPa
Pressure gauge port size (Rc) (IN/OUT: 2 locations)	1/8
Installation	Horizontal
Lubrication	Grease (Non-lube)
Weight	8.600 Kg

Dimensions

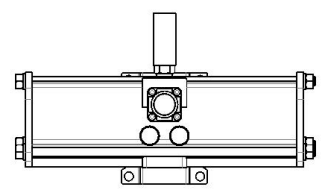
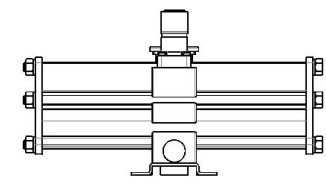
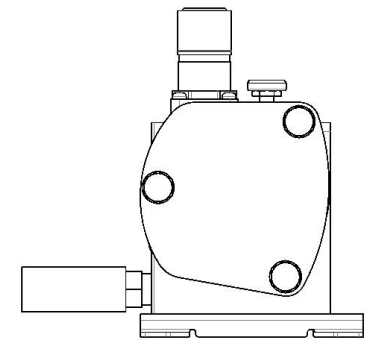
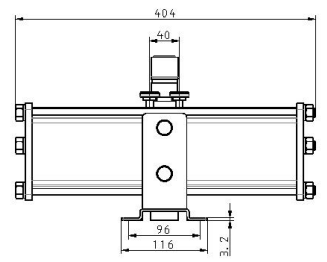
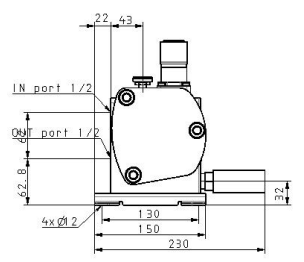
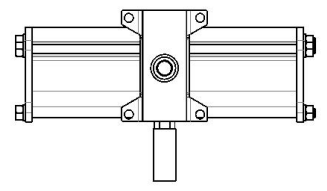

Additional information

Catalogue	VBA-VBAT-Dd_EU.pdf
Operation manuals	OM_VBA-OM-L007_EN-E.pdf MM_VBA20A_MM-L010EN-A.pdf VBA_MM_M009GB-B.pdf VBA40A_MM_L004EN-B.pdf