

AR20-D to AR60-D, Regulator & Regulator w/Backflow Function AR20-F02E-1-D

Datasheet

General series information

- ISO 8573-1:2010 compliant
- Up to 0.85 MPa set pressure
- Maximum flow rate up to 20000 l/min (ANR, 0.7MPa).



Standard specifications

Body Size	20
Backflow Function	None
Thread	F (G)
Port Size	02 (1/4)
Options	E [w/Square Embedded Type Pressure Gauge (w/Limit Indicator)]
Set pressure	1 (0.02 to 0.2 MPa setting)
Exhaust Mechanism	Relieving
Flow Direction	Left to Right
Knob	Downward
Pressure Units	Standard (Name Plate, Caution Plate for Bowl, and Pressure Gauge: MPa)
Construction	Relieving type
Pressure medium	Air
Maximum temperature of pressure medium	60 °C
Minimum temperature of pressure medium	-5 °C (with no freezing)
Maximum operating pressure	1.0 MPa
Proof pressure	1.5 MPa
Maximum ambient temperature	60 °C
Minimum ambient temperature	-5 °C (with no freezing)
Weight	0.157 Kg

Dimensions

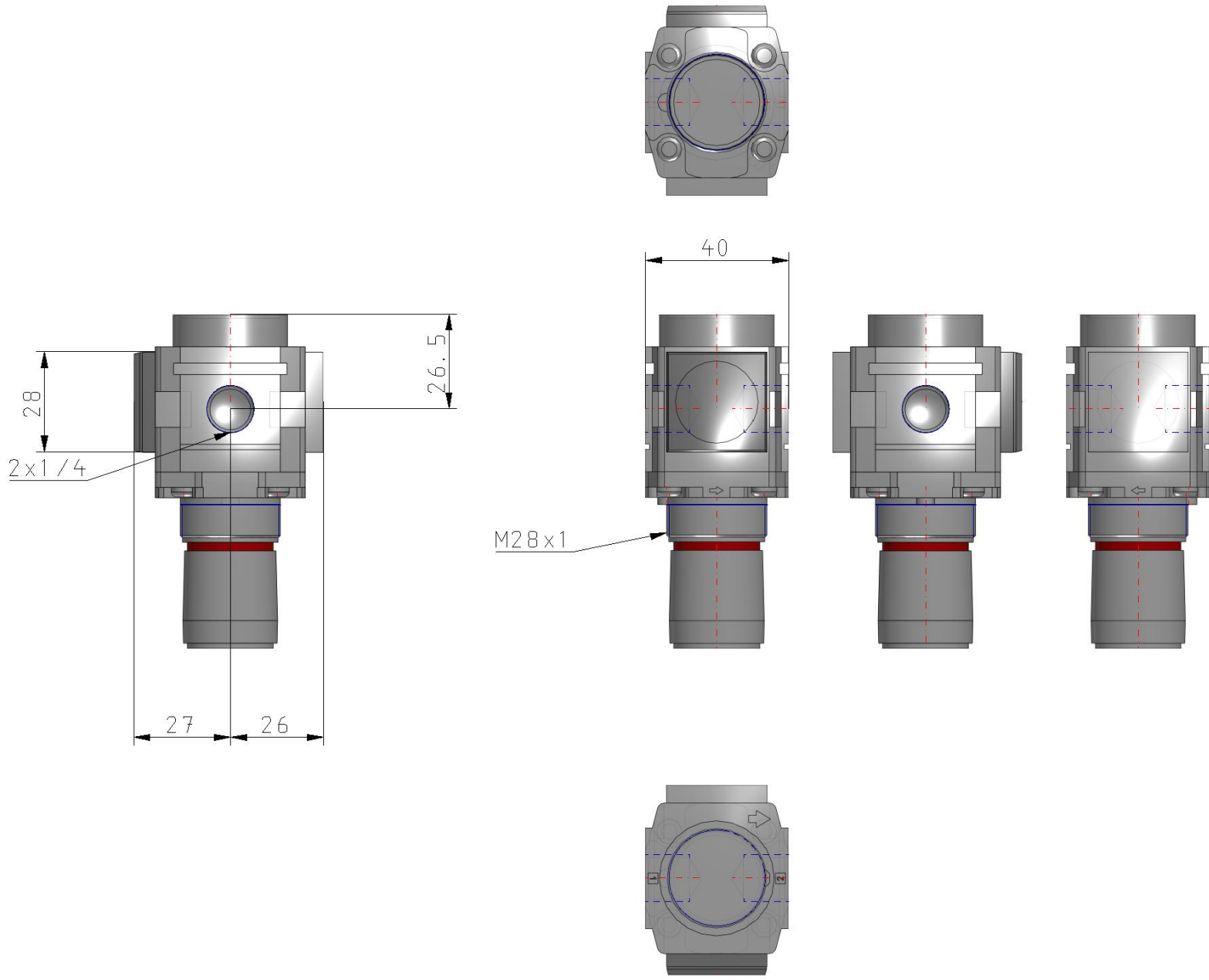

Additional information

Catalogue	ACD-D_EU.pdf
Installation manuals	IM_ARx-D_TF2Z352EN.pdf
Operation manuals	OM_AR20-60-D_OMX0055EN-B.pdf