

CXSJ, Dual Rod Cylinder, Compact Type

CXSJM10-30

Datasheet

General series information

- Dual rod cylinder, compact type
- Slide bearing or ball bushing bearing
- Bore size (mm): 6, 10, 15, 20, 25, 32
- Standard strokes (mm): 10, 20, 30, 40, 50, 75, 100
- Auto switches available
- Made to Order additionally released.



Double-acting, single-rod cylinder

Standard specifications

Bearing Style	M (Slide Bearing)
Bore Size	10 mm
Thread Type	Rc (or M Thread for 6 to 25 Bore)
Piping	Standard Porting
Stroke	30 mm
Auto Switch	No Switch
Lead Wire or Prewired Connector	0.5m [Or None in the Case of No Switch]
Number	2 pcs. [Or None in the Case of No Switch]
Option	None
Pressure medium	Air (non-lube)
Maximum operating pressure	0.7 MPa
Minimum operating pressure	0.1 MPa
Proof pressure	1.05 MPa
Maximum ambient temperature	60 °C
Minimum ambient temperature	-10 °C
Number of pneumatic connections	2 pcs.
Mode of operation of drive	Double acting

Type of cushioning	Rubber Bumper
Type of stroke reduction	Unilaterally retracted
Port size	M5
Piston speed	30 to 800 mm/s
Stroke adjustable range	0 to – 5 mm compared to the standard stroke
Weight	0.146 Kg

Dimensions

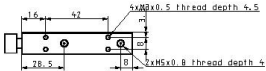
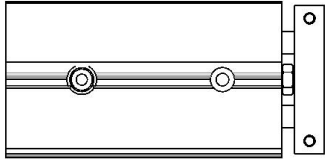
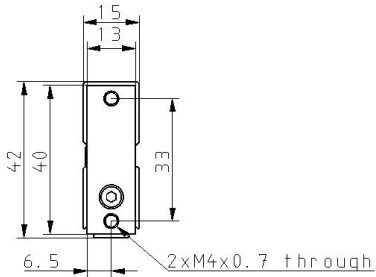
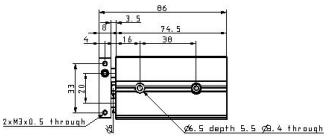
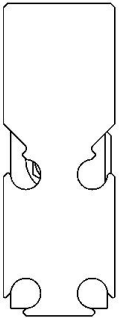

Constructions

CXSJM (Slide bearing)

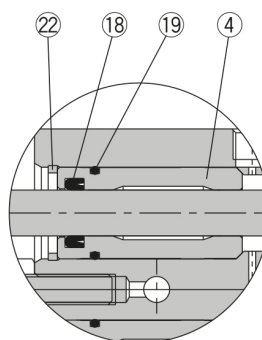
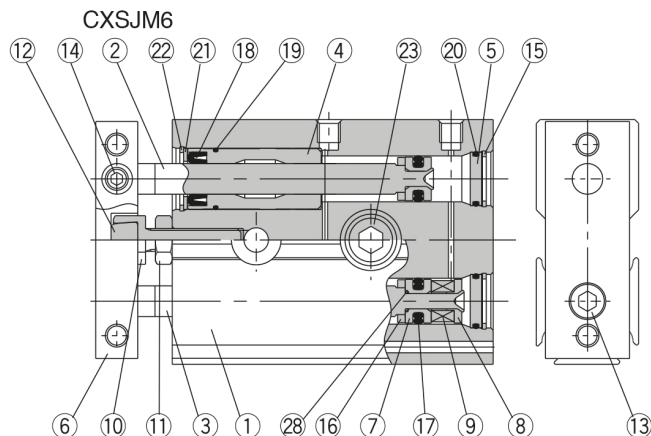

Rod cover

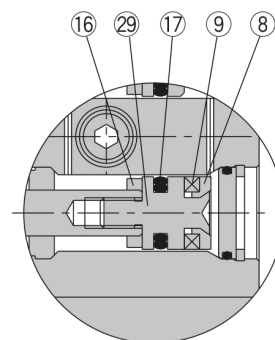

Piston rod B-side piston

Parts list

No.	Description	Material	Note
1	Housing	Aluminum alloy	Hard anodized
2	Piston rod A	Carbon steel <small>Note)</small>	Hard chrome plated
3	Piston rod B	Carbon steel <small>Note)</small>	Hard chrome plated
4	Rod cover/Bearing	Aluminum alloy	
5	Head cover	Aluminum alloy	Anodized
6	Plate	Aluminum alloy	Glossy, self-coloring hard anodized
7	Piston A	Aluminum alloy	Chromated
8	Piston B	Aluminum alloy	Chromated
9	Magnet	Magnetic material	
10	Bumper bolt	Carbon steel	Nickel plated
11	Hexagon nut	Carbon steel	Nickel plated
12	Bumper	Polyurethane	
13	Hexagon socket head cap screw	Chromium steel	Nickel plated
14	Hexagon socket head set screw	Chromium steel	Nickel plated
15	Snap ring	Special steel	Nickel plated

Note) Stainless steel for CXSJM6.

No.	Description	Material	Note
16	Bumper B	Polyurethane	
17	Piston seal	NBR	
18	Rod seal	NBR	
19	O-ring	NBR	
20	O-ring	NBR	
21	Seal retainer	Stainless steel	
22	Snap ring B	Special steel	Nickel plated
23	Bolt holder	Stainless steel	
24	Bearing spacer	Aluminum alloy	
25	Ball bushing	—	
26	Piston rod A	Special steel	Hard chrome plated
27	Piston rod B	Special steel	Hard chrome plated
28	O-ring	NBR	
29	Piston C	Stainless steel	

Additional information

Catalogue

[CXSJ_EU.pdf](#)

Operation manuals

[cxsj_op_man_cxsj-om0002h.pdf](#)