

ZH-A, Vacuum Ejector, Box Style/Body Ported Style, Metric

ZH18DSA-03-03-03

Datasheet

General series information

- One-touch fittings: Ø 6, 8, 10 and 12 mm. Screw-in connections: 1/8" to 1/2" (Rc/G).

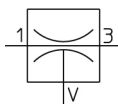

Vacuum ejector

Standard specifications

| | |
|--|--|
| Nozzle Diameter | 18 (Ø 1.8 mm) |
| Model | D (Body Ported Style) |
| Vacuum Pressure | S [-90 kPa; -89 kPa (Box Style)] |
| Port SUP. | 03 (Rc 3/8) |
| Port VAC. | 03 (Rc 3/8) |
| Port EXH. | 03 (Rc 3/8) |
| Accessories | W/ Bracket - W/o Silencer (or None in the Case of Box Style) |
| Pressure medium | Air |
| Maximum temperature of pressure medium | 50 °C |
| Minimum temperature of pressure medium | -5 °C |
| Maximum ambient temperature | 50 °C |
| Minimum ambient temperature | -5 °C |
| Pneumatic input connection | Screw-in R 3/8 |
| Pneumatic exhaust connection | Screw-in R 3/8 |
| Flow rate | 76 l/min (ANR) |
| Usable tubing material | Soft nylon;Nylon;Polyurethane |
| Pneumatic vacuum connection | Screw-in R 3/8 |
| Maximum Vacuum | -90 kPa |
| Nozzle nominal size [mm] | 1.8 mm |
| Weight | 0.055 Kg |

Dimensions

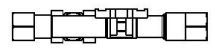
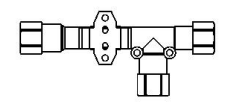
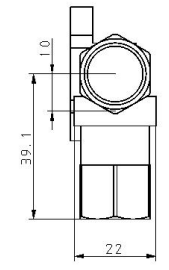
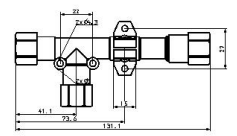
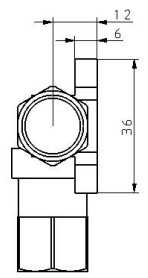

Constructions

Body ported type

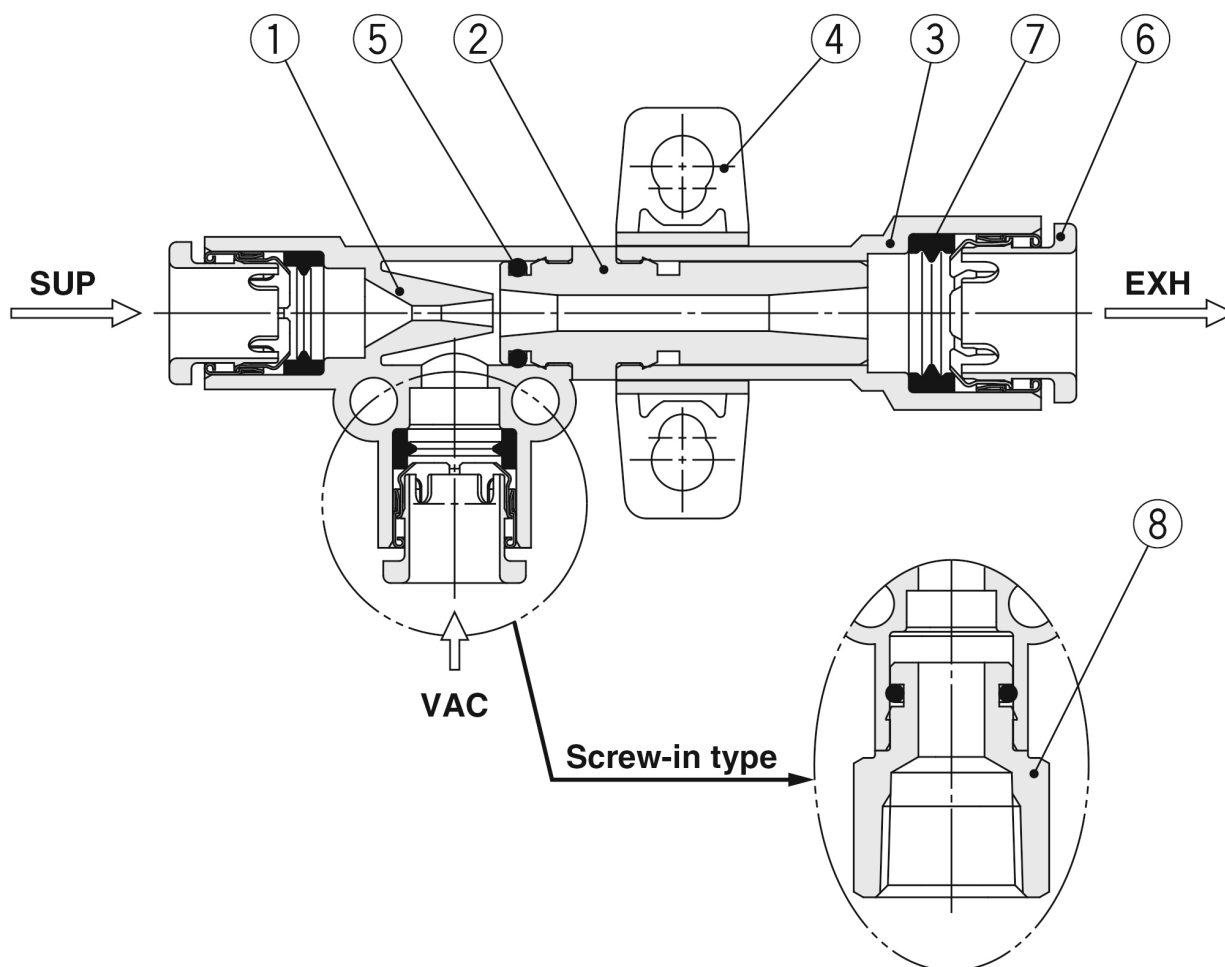

Component Parts

| No. | Description | Material | Note |
|-----|------------------|----------|------------------------------|
| 1 | Body | PBT | |
| 2 | Diffuser | PPS | Type S: Brown, Type L: Black |
| 3 | Adapter | PBT | |
| 4 | Standard bracket | PBT | Detachable (Accessory) |
| 5 | O-ring | NBR | Grease applied |
| 6 | Cassette | — | |
| 7 | Seal | NBR | Grease applied |
| 8 | Screw-in stud | Brass | Electroless nickel plating |

Additional information

| | |
|-------------------|-------------------------------------|
| Catalogue | ZH-C_EU.pdf |
| Operation manuals | OM_ZH_OM00401EN.pdf |