

## ARP20/30/40, Direct Operated Precision Regulator ARP20K-F02H

Datasheet

### General series information

- Air consumption decrease by 80% from the existing product (ARP3000).
- Allows precise control of air pressure.
- Standard backflow function (ARP20K/30K/40K).
- Standard digital pressure switches.
- Compatible with the new AC spacers.

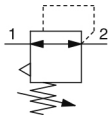

Pressure regulator with backflow function

### Standard specifications

Size	20
Backflow Function	K (Backflow Function)
Thread	F (G)
Port Size	02 (1/4)
Accessory	H (Set Nut for Panel Mount)
Specifications	0.005 to 0.4MPa Setting
Pressure Unit	Name plate & Pressure Gauge in SI Units: MPa
Pressure medium	Air
Maximum temperature of pressure medium	60 °C
Minimum temperature of pressure medium	-5 °C (with no freezing)
Maximum operating pressure	0.7 MPa
Proof pressure	1.2 MPa
Maximum ambient temperature	60 °C
Minimum ambient temperature	-5 °C (with no freezing)
Approvals	No need
Sensitivity	Within 0.2% F.S.
Repeatability	Within ±1% F.S. (or ±3 kPa)
Set pressure range	0.005 - 0.4 MPa

Weight

0.181 Kg

---

# Dimensions

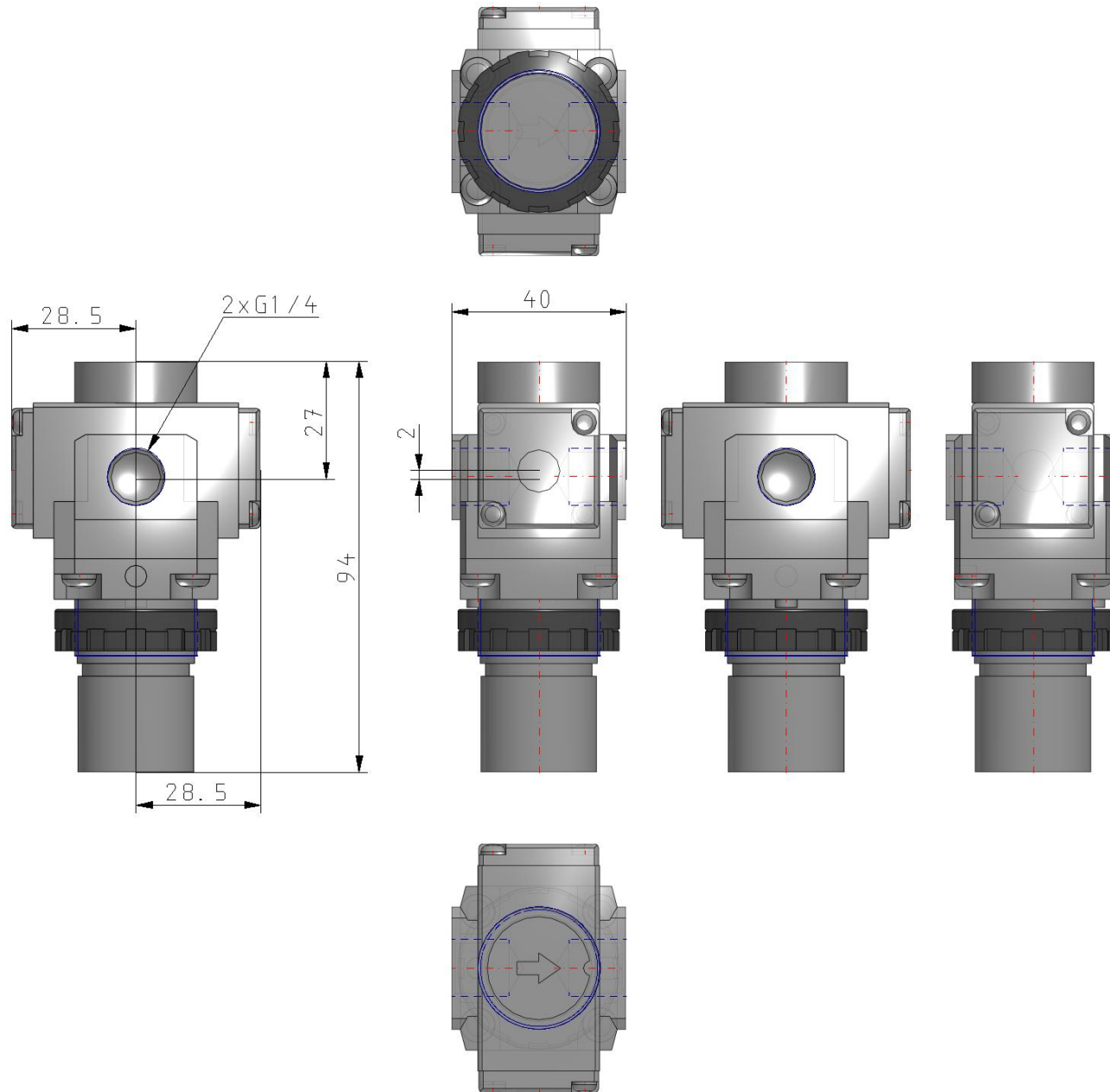

## Additional information

Catalogue	<a href="#">ARP20-30-40_EU.pdf</a>
Installation manuals	<a href="#">IM_ARP_SMU48EN.pdf</a>
Operation manuals	<a href="#">OM_ARPxK_OML0043EN-B.pdf</a> <a href="#">OM_ARP_OML0044EN-A.pdf</a>