

## IR1000/2000/3000, Precision Regulator IR2000-F02

Datasheet

### General series information

- Precision regulator
- Regulating pressure range (MPa): 0.005 to 0.8 depending on model
- Compact and lightweight
- Bracket & pressure gauge can be mounted on either the front or back
- 2 air operated models.

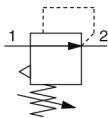

Pressure control valve, relieving pressure regulator, adjustable

### Standard specifications

Body Size	2 (IR2000)
Type of Setting	0 (Basic [Handle])
Set Pressure	0 (0.005~0.2MPa [IR1000/2000] or 0.01~0.2MPa [IR3000])
Thread	F [G(PF)]
Port Size	02 (1/4 [IR2000/3000])
Accessory	None
Suffix 1	Standard
Suffix 2	None
Made to Order	None
Switch Specifications	None
Pressure medium	Air
Maximum temperature of pressure medium	60 °C
Minimum temperature of pressure medium	-5 °C [with no freezing]
Maximum operating pressure	1.0 MPa
Minimum operating pressure	+0.05 Mpa
Maximum ambient temperature	60 °C
Maximum ambient temperature with magnet	-5 °C [with no freezing]
Approvals	No need

Sensitivity	Within 0.2% of full span
Repeatability	Within 0.5% of full span
Set pressure range	0.005 - 0.2 MPa
Linearity	Within 1% of full span
Air consumption (At supply pressure of 1.0 MPa)	4.4 l/min (ANR) or less
Input signal pressure	0.01 - 0.8 Mpa
Weight	0.300 Kg

# Dimensions

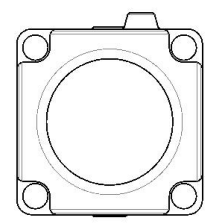
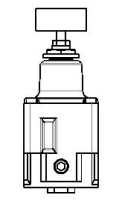
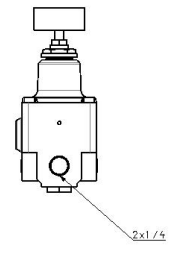
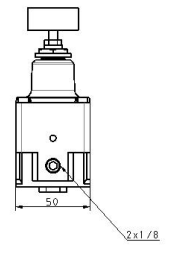
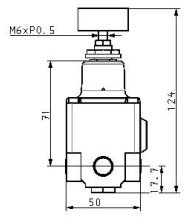
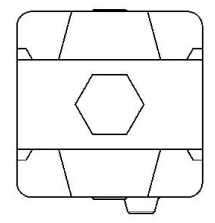

# Constructions

## Construction

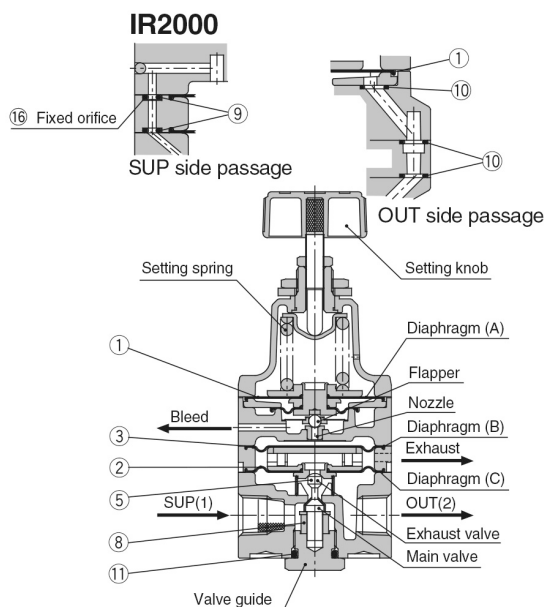

### Replacement Parts

No.	Description	Material	IR20□0	
			Part no.	Qty.
1	Diaphragm assembly	NBR, other	P362020-2	1
2	Diaphragm assembly	NBR, other	P362020-5	1
3	Diaphragm	NBR, other	P36202019	1
4	Valve	Stainless steel, NBR	—	—
5	Valve	Stainless steel, NBR	P36202068#1	—
6	Valve	Brass, NBR	—	—
7	Valve	Brass, NBR	—	1
8	Damper	NBR, other	P36202026	2
9	O-ring	H-NBR	ø1.42 x 1.52	3
10	O-ring	NBR	ø4.5 x 1	1
11	O-ring	NBR	JISB2401P11	—
12	O-ring	NBR	—	—
13	O-ring	NBR	—	—
14	Seal (A)	NBR	—	—
15	Seal (B)	NBR	—	1
16	Fixed throttle	Stainless steel	P36202018	
Repair kit no. (A set of above nos. ① to ⑮.)			KT-IR2000	

## Additional information

Catalogue	<a href="#">IR1000-2000-3000-B_EU.pdf</a>
Operation manuals	<a href="#">OM_IR30-OM00002EN-F.pdf</a> <a href="#">IR10-OM00006_GB.pdf</a> <a href="#">OM_IR20-OM00004EN-E.pdf</a> <a href="#">OM_IR10_OM00002EN-E.pdf</a> <a href="#">OM_IR20_OM00002EN-F.pdf</a> <a href="#">OM_IR30_OM00004EN-F.pdf</a>