

VHK-A, Finger Valve, One-touch Fitting

VHK3A-04F-04F

Datasheet

General series information

- 1(P)/2(A) One-touch fitting.

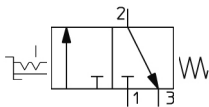

Directional control valve 3/2-way valve, closed normal position return with control mechanism by turning return with mechanical control spring

Standard specifications

Valve	3 (3-Port Valve)
1(P) Applicable Tubing O.D.	ø 4
2(A) Applicable Tubing O.D.	ø 4
Knob Colour	Grey (2-port); Blue (3-port)
Bracket	None
Pressure medium	Air
Maximum temperature of pressure medium	60 °C
Minimum temperature of pressure medium	0 °C
Maximum operating pressure	1.0 MPa
Minimum operating pressure	-100 kPa
Proof pressure	1.5 MPa
Maximum ambient temperature	60 °C
Minimum ambient temperature	0 °C
Usable tubing material	Nylon,Soft nylon,Polyurethane
Weight	0.015 Kg

Dimensions

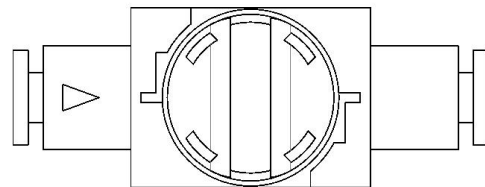
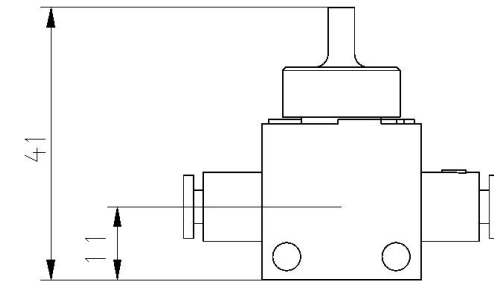
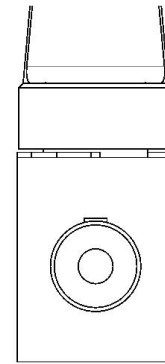
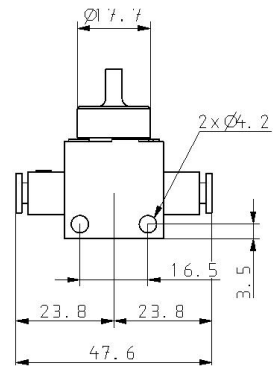
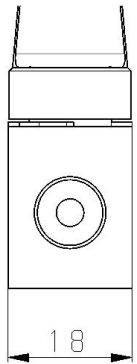

Specifications are subject to change without prior notice and any obligation on the part of the manufacturer.

Constructions

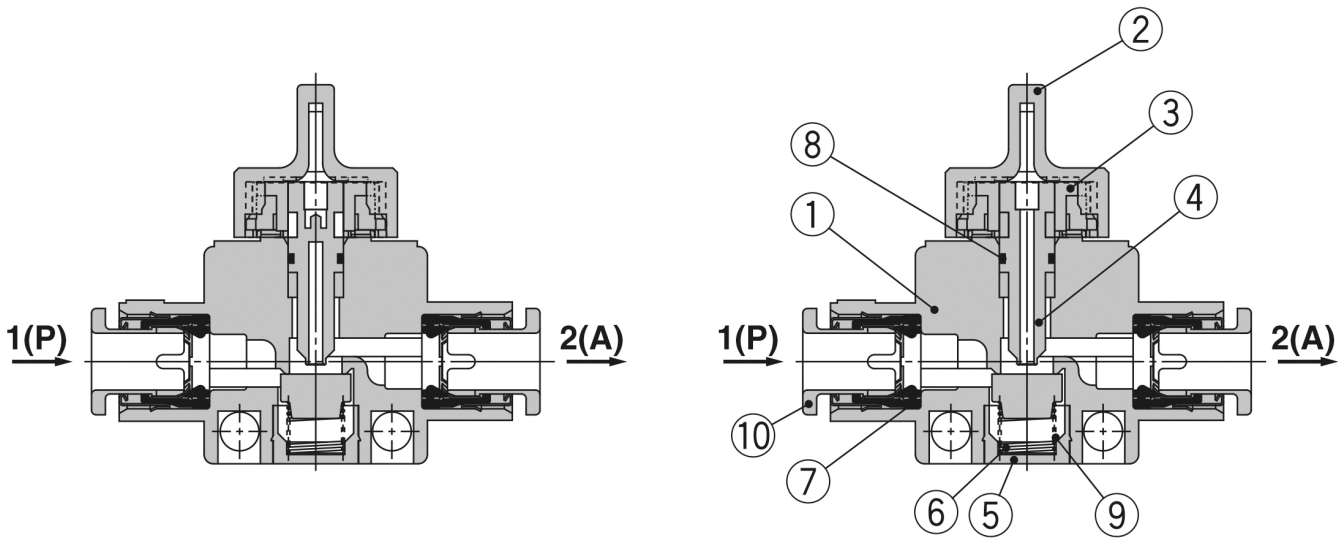

No.	Description	Material	Note
1	Body	PBT	
2	Knob	POM	
3	Cam ring	POM	
4	Stem	POM	
5	Spring guide	Brass	Electroless nickel plated
6	Spring	Stainless steel	
7	Seal	NBR	
8	O-ring	NBR	
9	Valve	NBR	
10	Cassette	—	

Additional information

Catalogue

[VHK-Aa_EU.pdf](#)