

Metric - KS KSL04-01S

Datasheet

General series information

- Rotary, One-touch fitting (standard)
- Metric threads
- Tube OD: Ø4, Ø6, Ø8, Ø10, Ø12
- Maximum operating pressure: 1.0 MPa
- Ambient & fluid temperature: -5 to 60°C

Standard specifications

Model	L (Male Elbow)
Applicable Tube OD	Ø4 mm
Port Size	01 (R[PT]1/8)
Sealant	S [Sealant]
Pressure medium	Air
Maximum ambient temperature	60 °C
Minimum ambient temperature	-5 °C (no Freezing)
Usable tubing material	Nylon, Soft nylon, Polyurethane
Weight	0.014 Kg

Dimensions

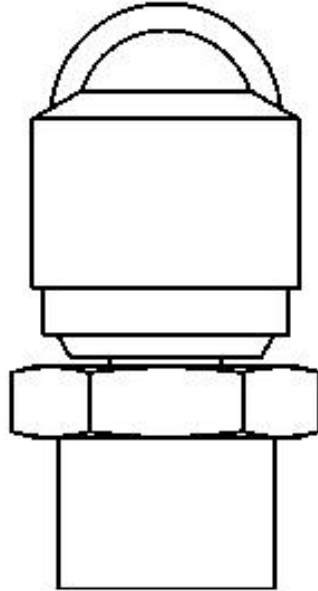

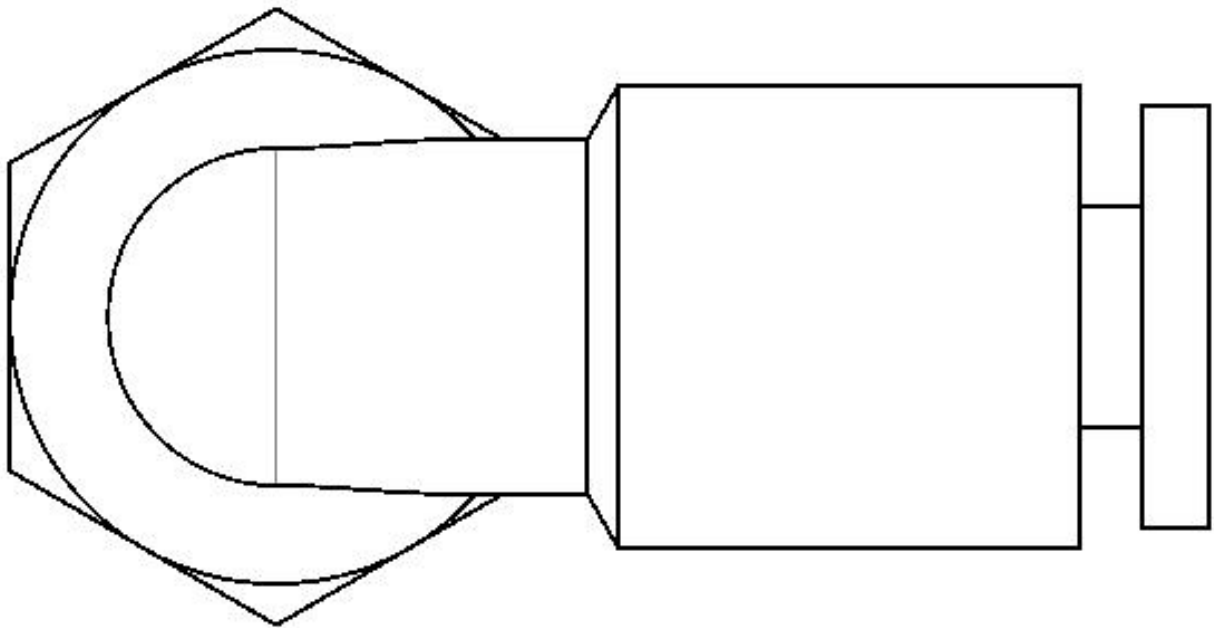

Additional information

Catalogue

[KS_KX_EU.pdf](#)