

# VM200, 200 Series 2/3 Port Mechanical Valve

## VM230-F02-40A

Datasheet

### General series information

- Fluid: Air/Inert gas.
- Large flow capacity.
- Possible to choose mounting method with side ported.
- Variety of actuator types.

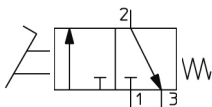

*Directional control valve 3/2-way valve, closed normal position With manual control pedal Return with mechanical control spring*

### Standard specifications

Number of Ports	3 Port
Body Option	Side Mounting
Port Size	F02 (G 1/4)
Actuator type	40 (Foot Pedal)
Suffix	None
Bracket	None
Pressure medium	Air/Inert gas
Maximum temperature of pressure medium	60 °C
Minimum temperature of pressure medium	-5 °C (No freezing)
Maximum operating pressure	1.0 MPa
Minimum operating pressure	0 MPa
Maximum ambient temperature	60 °C
Minimum ambient temperature	-5 °C (No freezing)
Pneumatic input connection	G 1/4
Pneumatic exhaust connection	G 1/4
Function in normal position	Exhausted
Type of piloting	Directly
Valve return	Mechanical spring
Flow rate	1088 l/min

Critical pressure ratio	0.4
Sonic conductance dm <sup>3</sup> /(s·bar)	4
Actuation type	Manually
Weight	0.450 Kg

Specifications are subject to change without prior notice and any obligation on the part of the manufacturer.

# Dimensions

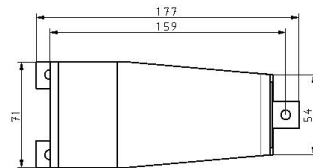
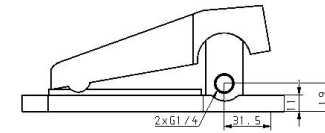
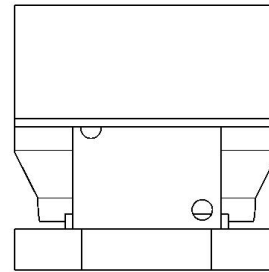
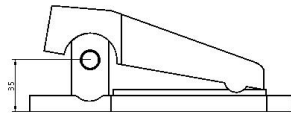
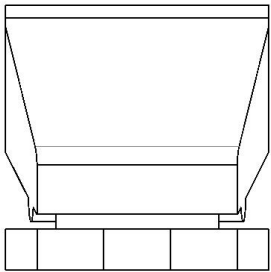
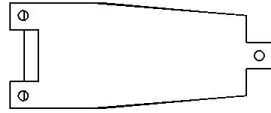

Specifications are subject to change without prior notice and any obligation on the part of the manufacturer.

## Constructions

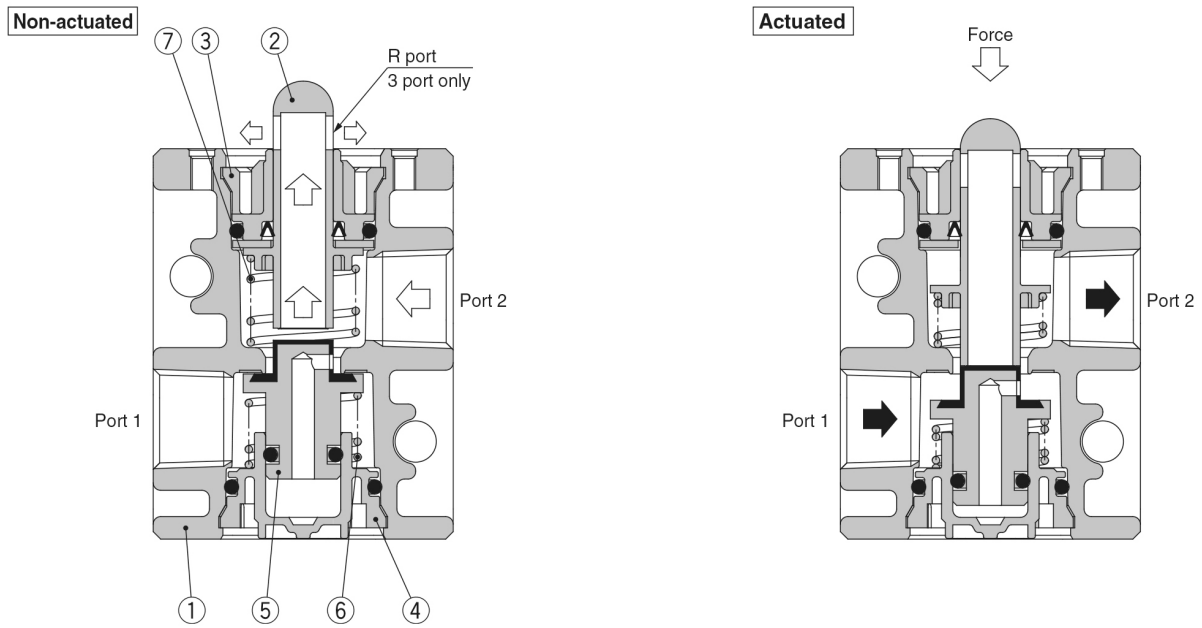

### Component Parts

No.	Description	Material	Note
1	Valve	ADC	White coated
2	Plunger	Polyacetal	2 port Grey
			3 port White
3	Plunger retainer	PBT	
4	Cover	PBT	
5	Inner valve	NBR, Brass	
6	Spring	Stainless steel	
7	Spring	Spring steel	

## Additional information

Catalogue	<a href="#">VM100-200-A_EU.pdf</a>
Installation manuals	<a href="#">IM_VM100_TF2Z478EN-C.pdf</a>