

KKA*P-*F, S-Couplers, Stainless Steel, Female Thread KKA3P-02F

Datasheet

General series information

- Female thread.
- Body size: 1/8, 1/4, 1/2, 3/4, 1, 1 1/4.
- Applicable Port Size: Rc1/8, Rc1/4, Rc3/8, Rc1/2, Rc3/4, Rc1, Rc1 1/4, Rc1 1/2.

Standard specifications

Body Size	3 (1/8)
Port Size	Rc 1/4
Built-in Check Valve	w/Check Valve
Pressure medium	Air, Water
Maximum operating pressure	1.0 MPa
Minimum operating pressure	-100 kPa
Proof pressure	10 MPa
Maximum ambient temperature	150 °C (not be used with steam)
Minimum ambient temperature	-5 °C (with no freezing)
Effective Area	17.4 mm ²
Sealing principle	With male thread seal
Non-greased specification	No grease is used. Rubber: Fluorine coated, (Metal sliding parts: Plated with fluorine-contained material)
Material	Metal part: Stainless steel 304, Rubber material: Fluoro rubber (Special FKM)
Weight	0.039 Kg

Dimensions

Rc 1 / 4

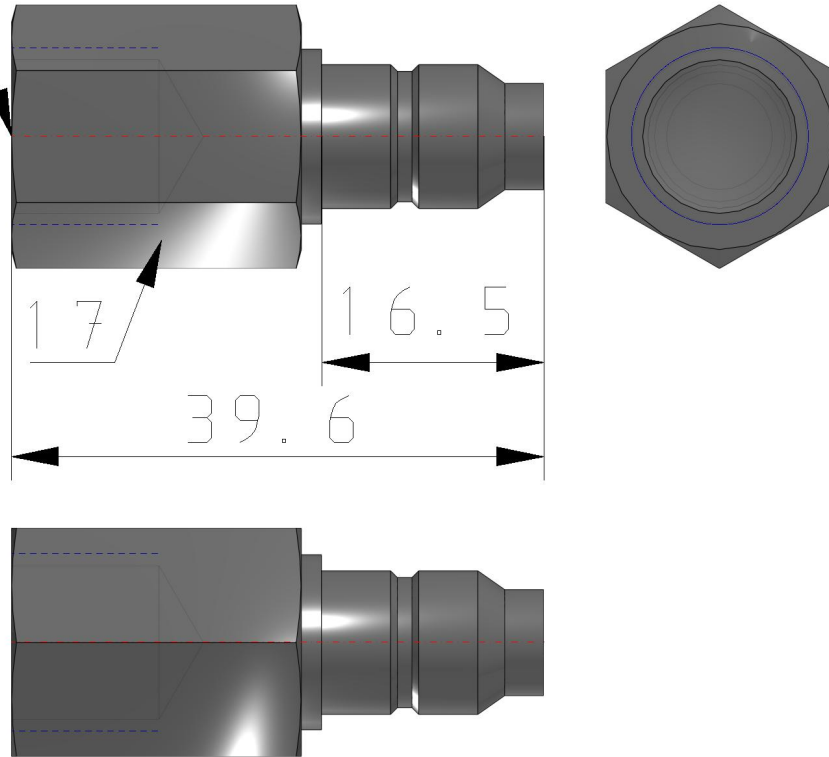

Additional information

Catalogue

[KK-C_EU.pdf](#)